

CVA 7440
Built-in coffee machine



- Large clear text display with sensor controls – DirectSensor
- Perfectly positioned: thanks to the patented CupSensor
- 2 coffees at once at the touch of a button – OneTouch for Two
- Always freshly ground – AromaticSystemFresh
- Convenient when hosting lots of guests – coffee/tea pot function

EAN: 4002516426745 / Material number: 11754280 / Old Material Number: 29744030USA

| Construction type and design | |
|---|---------------|
| Built-in bean-to-cup coffee machine | • |
| VitroLine | • |
| ArtLine | • |
| Color | Graphite grey |
| Consumer benefits | |
| AromaticSystemFresh | • |
| OneTouch preparation | • |
| One Touch and OneTouch for Two | • |
| DoubleShot | • |
| Programmable User profile | 10 |
| Flavor preserving conical grinding unit | • |
| Grinding grade selectable | • |
| Ground quantity programmable | • |
| Water quantity programmable | • |
| Water temperature programmable | • |
| Amount of milk can be programmed | • |
| Amount of milk froth can be programmed | • |
| Pre-brewing programmable | • |
| TeaTimer | • |
| Control panel | |
| Networking with Miele@home | • |
| Control panel | DirectSensor |
| CupSensor | • |
| Height adjustment of infinitely adjustable central spout min in in.(cm) | 1 5/8 (4.0) |
| Height adjustment of infinitely adjustable central spout max in in.(cm) | 6 1/2 (16.5) |
| PerformanceMode | • |
| EasyClick milk container | • |
| ComfortDoor | • |
| Hidden door handle | • |
| BrilliantLight | • |
| Expert mode | • |
| MultiLingua | • |
| No. of bean types | 1 |
| No. of bean containers | 2 |
| Bean container capacity, each in oz (g) | 300 |
| Capacity of bean container B in g | 300 |
| Bean container capacity, total in oz (g) | 21.16 (600) |
| Removable bean container | • |
| Capacity of water container in fl oz (l) | 91.3 (2.7) |
| Milk container capacity in l | 0.7 |
| Drip tray capacity in fl oz (l) | 54.1 (1.6) |
| Easily accessible containers | • |
| Time-of-day display | • |
| Time synchronization | • |
| Date display | • |
| Programmable switch-on time | • |
| Programmable switch-off time | • |

CVA 7440
Built-in coffee machine



EAN: 4002516426745 / Material number: 11754280 / Old Material Number: 29744030USA

| | |
|--|--------|
| Programmable stand-by time | • |
| Individual settings | • |
| Beverages | |
| Adjustable beverage portion size in ml | 20-300 |
| Ristretto, single | • |
| Ristretto, double | • |
| Espresso, single | • |
| Espresso, double | • |
| Coffee, single | • |
| Coffee, double | • |
| Long coffee, single | • |
| Long coffee, double | • |
| Cappuccino, single | • |
| Cappuccino, double | • |
| Latte macchiato, single | • |
| Latte macchiato, double | • |
| Hot milk, single | • |
| Latte macchiato, double | • |
| Milk froth, single | • |
| Milk froth, double | • |
| Espresso macchiato, single | • |
| Espresso macchiato, double | • |
| Cappuccino italiano, single | • |
| Cappuccino italiano, double | • |
| Flat white, single | • |
| Flat white, double | • |
| Café au lait, single | • |
| Café au lait, double | • |
| Caffè latte, single | • |
| Caffè latte, double | • |
| Caffè americano, single | • |
| Caffè Americano, double | • |
| Long black, single | • |
| Long black, double | • |
| Allwater | • |
| Warm water, double | • |
| Hot water, single | • |
| Hot water, double | • |
| Black tea, single | • |
| Black tea, double | • |
| Herbal tea, single | • |
| Herbal tea, double | • |
| Fruit tea, single | • |
| Fruit tea, double | • |
| Green tea, single | • |
| Green tea, double | • |
| White tea, single | • |
| White tea, double | • |
| Japanese tea, single | • |
| Japanese tea, double | • |
| Chai latte, single | • |

CVA 7440
Built-in coffee machine

EAN: 4002516426745 / Material number: 11754280 / Old Material Number: 29744030USA

| | |
|---|----------------|
| Chai latte, double | • |
| Coffee pot | • |
| Teapot | • |
| Efficiency and sustainability | |
| Energy-saving Eco mode option | • |
| Power rating in standby mode in W | 0.6 |
| Power rating in networked standby in W | 0.9 |
| Time until automatic switch to off mode in min | 20 |
| Time until automatic switch to standby in min | 20 |
| Time until automatic switch to networked standby in min | 20 |
| Cleaning convenience | |
| Manual descaling | • |
| Automatic rinsing of the milk pipework from the water container | • |
| Convenient cleaning programs | • |
| Auto-Off function | • |
| ComfortClean | • |
| Removable milk pipework | • |
| Removable brew unit | • |
| Adjustable water hardness | • |
| Safety | |
| System lock | • |
| Technical data | |
| Niche width min in in.(mm) | 22 1/8 (560) |
| Niche width max in in.(mm) | 22 3/8 (568) |
| Niche height min in in.(mm) | 17 3/4 (450) |
| Niche height max in in.(mm) | 17 7/8 (452) |
| Niche depth in in.(mm) | 19 3/4 (500) |
| Appliance width in in.(mm) | 23 1/2 (595) |
| Appliance height in in.(mm) | 18 (455) |
| Appliance depth in in.(mm) | 18 3/4 (475) |
| Depth with door open in in.(cm) | 42 5/8 (108.0) |
| Total connected load in kW | 1.45 |
| Voltage in V | 120 |
| Fuse rating in A | 15 |
| Number of phases | 1 |
| Length of electrical wire in ft (m) | 6 (2.0) |
| Accessories supplied | |
| Glass milk container | • |
| Descaling tablets | • |
| Cleaning tablets | • |
| Milk pipework cleaner | • |
| Miele coffee 250 gr | • |

CVA 7440
Built-in coffee machine



EAN: 4002516426745 / Material number: 11754280 / Old Material Number: 29744030USA

Available display languages

Available display languages via MultiLingua

bahasa malaysia, dansk,
deutsch, eesti, english,
english (AU), english (CA),
english (GB), english (US),
español, français, français
(CA), français (FR), hrvatski,
italiano, latviesu, lietuviu,
magyar, nederlands,
norsk, polski, portugûês,
русский, română,
slovenčina, slovenščina,
srpski, suomi, svenska,
türkçe, українська, čeština,
ελληνικά, , , ,
,

CVA 7440 Built-in coffee machine

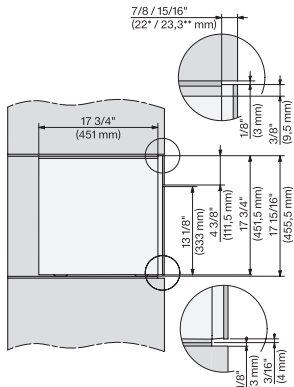

CVA7440, CVA7840, installation drawing, side view, 60 cm, Flush inset, NA

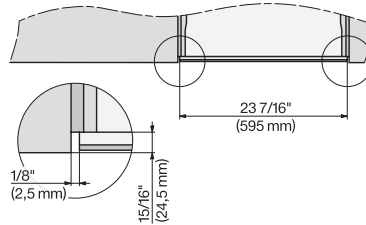

CVA7440, CVA7445, CVA7840, CVA7845, installation drawing, view from above, 60 cm, Flush inset

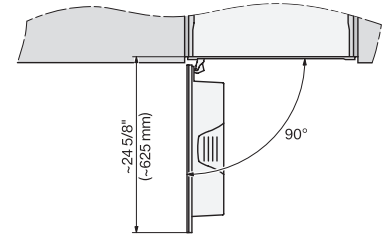

CVA7440, CVA7445, CVA7840, CVA7845, installation drawing, view from above, 60 cm, Flush inset

7/8" – 22* mm – Glass, 15/16" – 23.3** mm – Stainless steel, .

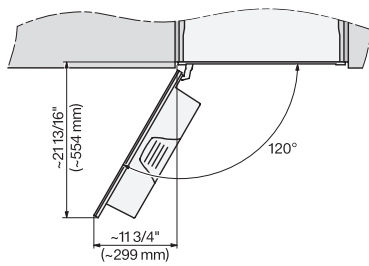

CVA7440, CVA7445, CVA7840, CVA7845, installation drawing, view from above, 60 cm, Flush inset

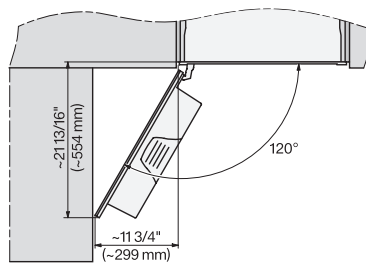

CVA7440, CVA7445, CVA7840, CVA7845, installation drawing, view from above, 60 cm, Flush inset

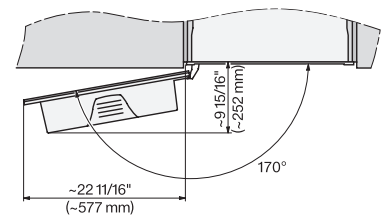

CVA7440, CVA7445, CVA7840, CVA7845, installation drawing, view from above, 60 cm, Flush inset

CVA 7440 Built-in coffee machine

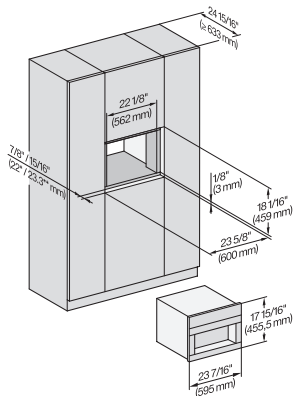

CVA7440, CVA7745, CVA7840, CVA7845, installation drawing, built in, 60 cm, Flush inset

7/8" – 22" mm – Glass, 15/16" – 23.3** mm – Stainless steel

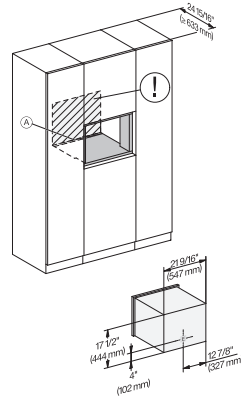

CVA7440, CVA7840, installation drawing, installation, 60 cm, Flush inset

A – Cut-out (1 1/2" x 20" / 38 mm x 508 mm) in the bottom of the cabinet for power cord and ventilation, – Electrical and water supplies are recommended to be placed in adjacent cabinetry., Additional cabinet depth is required when placing the electrical and water supplies behind the appliance., E = Electric connection

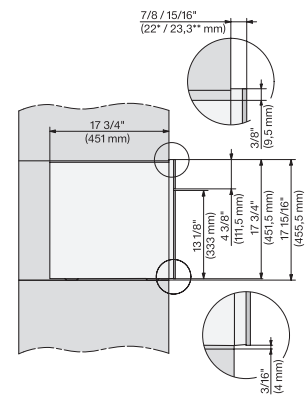

CVA7440, CVA7840, side view, 60 cm, Proud

7/8" – 22" mm – Glass, 15/16" – 23.3** mm – Stainless steel

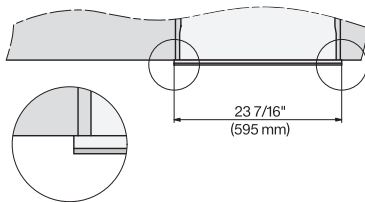

CVA7440, CVA7445, CVA7840, CVA7845, installation drawing, view from above, 60 cm, Proud

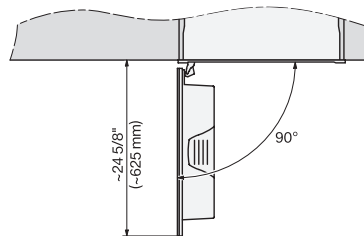

CVA7440, CVA7445, CVA7840, CVA7845, installation drawing, view from above, 60 cm, Proud

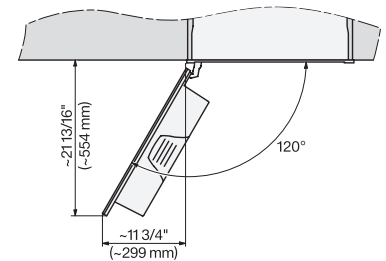

CVA7440, CVA7445, CVA7840, CVA7845, installation drawing, view from above, 60 cm, Proud

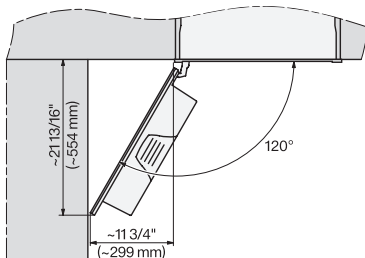

CVA7440, CVA7445, CVA7840, CVA7845, installation drawing, view from above, 60 cm, Proud

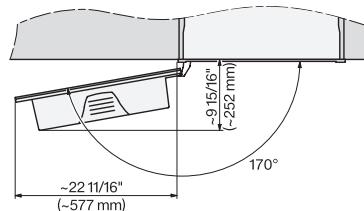

CVA7440, CVA7445, CVA7840, CVA7845, installation drawing, view from above, 60 cm, Proud

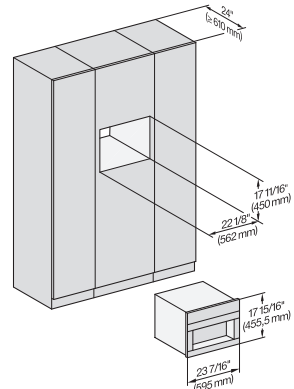

CVA7440, CVA7445, CVA7840, CVA7845, installation drawing, built in, Einbau, 60 cm, Proud

CVA 7440 Built-in coffee machine

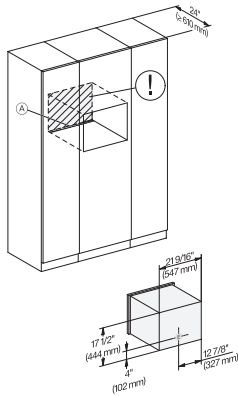

CVA7440, CVA7840, installation drawing, installation,
60 cm, Proud

A – Cut-out (1 1/2" x 20" / 38 mm x 508 mm) in the bottom of the cabinet for power cord and ventilation. – Electrical and water supplies are recommended to be placed in adjacent cabinetry. Additional cabinet depth is required when placing the electrical and water supplies behind the appliance. E = Electric connection