



5 SERIES WALL HOODS – 18” HIGH

Viking 5 Series – VWH

APPEARANCE AND DESIGN

- Backlit LED knobs extend and illuminate to control lighting level and fan speed, then fully retract when not in use
- Seamless design provides a refined finish to your kitchen
- Tough-box ventilator housing protects blower and quietly removes smoke and odor
- Quietest hood and ventilator combination in the industry
- Multi-speed ventilator control knob allows precise adjustment to desired fan speed
- Maintenance-free ventilators never need to be cleaned with the commercial-type hood filters doing the dirty work
- Cook with peace of mind as the built-in heat sensor activates the ventilator to full power if cooking temperatures reach uncomfortable levels
- Ventilators must be purchased separately and are available in internal, external, and in-line models (See Ventilation guide for compatibility) Must use Viking ventilator kits with Viking hoods

BRIGHT LED LIGHTING

- Dimmable lighting controls provide custom illumination for enhanced surface cooking visibility
- Long-life LED light bulbs are energy efficient and easily replaceable
- Heat lamps conveniently keep food warm until ready to serve (not available on Island Hoods)

EASY CLEANUP

- Commercial-type baffle filters efficiently remove heat and grease vapors from the air
- Stainless steel dishwasher-safe filters are easily removed for quick cleaning
- Low-profile filter system reduces interior hood space, leaving less surface to clean
- Removable trough collects liquefied grease for convenient disposal



INTERIOR, EXTERIOR, OR IN-LINE VENTILATORS

- Wall hoods
 - Interior-power ventilator kits – 300 CFM (VINV300), 600 CFM (VINV600), or 1,200 CFM (VINV1200)
 - Exterior-power ventilator kits – 900 CFM (DEV900) or 1,500 CFM (DEV15001)
 - In-line-power ventilator kits – 1,200 CFM (DIL1200)
 - See specification chart for compatibility
- One ventilator, one duct run for any size hood/ventilator

MODEL NUMBERS

- VWH53048 – 30”W. Wall Hood
- VWH53648 – 36”W. Wall Hood
- VWH54848 – 48”W. Wall Hood
- VWH56048 – 60”W. Wall Hood

ACCESSORIES

- DCW30SS – Wall Hood Duct Cover for 30” Hood
- DCW36SS – Wall Hood Duct Cover for 36” Hood
- DCW48SS – Wall Hood Duct Cover for 48” Hood
- DCW60SS – Wall Hood Duct Cover for 60” Hood
- WGP30SS – Wall Hood Warming Shelf Panels for 30” Hood
- WGP36SS – Wall Hood Warming Shelf Panels for 36” Hood
- WGP48SS – Wall Hood Warming Shelf Panels for 48” Hood
- BKS30SS – Wall Hood Backsplash for 30” Hood
- BKS36SS – Wall Hood Backsplash for 36” Hood
- BKS48SS – Wall Hood Backsplash for 48” Hood
- BKS60SS – Wall Hood Backsplash for 60” Hood

COLOR FINISHES

- Stainless Steel (SS)
- Available in 18 Exclusive Color Finishes: Antique Bronze (AN), Blush (BH), Cast Black (CS), Daffodil (DA), Damascus Gray (DG), Eucalyptus (EU), Golden Hour (GH), Ivy (IV), Martini (MA), Nantucket (NA), November Sky (NS), Onyx (ON), Pure White (PW), Slate Blue (SB), Spiced Cider (SC), Squall (SQ), Splash (SP), and Valentine (VA)



BRUSHED BRASS ACCENT

- Available on Stainless Steel Finish (standard order) and Exclusive Color Finishes (special order)
- Brass Accent includes logo

WARRANTY

- 2-year full – complete product
- 90-day full – cosmetic parts such as glass, painted items and decorative items
- 5-year limited – ventilator motors



5 SERIES WALL HOODS – 18” HIGH

Viking 5 Series – VWH

18" WALL HOODS				
DESCRIPTION	VWH53048	VWH53648	VWH54848	VWH56048
Overall/Duct Cover Width	29-7/8" (75.9 cm)	35-7/8" (91.1 cm)	47-7/8" (121.6 cm)	59-7/8" (152.1 cm)
Overall Depth	24" (61.0 cm)			
Overall Height	18" (45.7 cm)			
Duct Cover Depth	12" (30.5 cm)			
Duct Cover Height	12" (30.5 cm)			
Heat Lamps	1	1	2	2
Interior Ventilator Kits	VINV300/600/1200	VINV300/600/1200	VINV1200*	VINV1200*
Exterior Ventilator Kits	DEV900	DEV900	DEV15001**	DEV15001**
In-Line Ventilator Kits	DIL1200	DIL1200	DIL1200	DIL1200
Interior Duct Size	7"/10" (17.8/25.4 cm)		10" (25.4 cm)	
Exterior Duct Size	10" (24.5 cm)			
Interior—Maximum Amps	4.2/5.2/8.2		10.8	
Exterior—Maximum Amps	8.0		8.5	
In-Line—Maximum Amps	7.2		9.6	10.0

Please do not prepare installation from brochure data only. See installation instructions for important clearance/installation information.
 ** Disregard when using recirculating kits. 460 CFM blower is shipped with hood. Maximum duct run is 50 ft.

	A (Hood width)
30"W.	29-7/8" (76.2 cm)
36"W.	35-7/8" (91.1 cm)
48"W.	47-7/8" (121.6 cm)
60"W.	59-7/8" (152.1 cm)

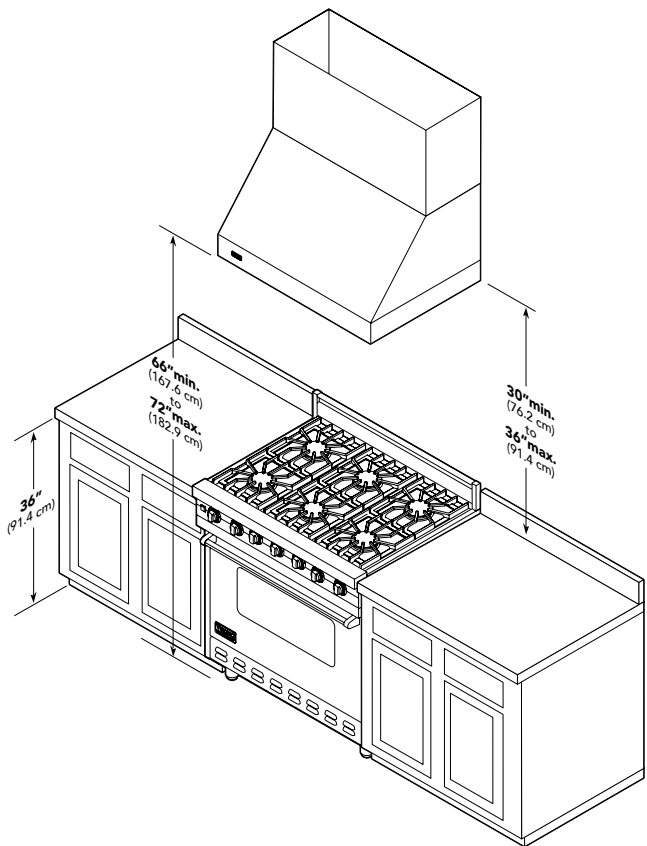
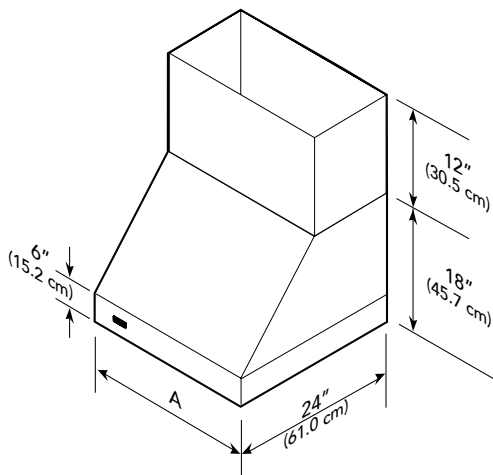

VIKING RANGE, LLC 111 FRONT STREET GREENWOOD, MISSISSIPPI 38930 USA

For detailed product information, model numbers, or to request a quote call 1-888-845-4641 or visit vikingrange.com
 © 2025 Viking Range, LLC All rights reserved. Specifications subject to change without notice.

