

Combination steam oven

GS480720 GS481720

GAGGENAU



You can find additional information and explanations online.
Scan the QR code on the title page.



Table of contents

1	IMPORTANT SAFETY INSTRUCTIONS	4	8.7	Steam injection	21
1.1	Safety definitions	4	8.8	Starting steam removal	21
1.2	General information	4	8.9	Stopping steam removal early	21
1.3	Safe use	4	8.10	Opening the appliance door automatically after the cooking process	21
1.4	Child safety	5	8.11	Deactivating automatic appliance door opening	22
1.5	Safe use of the meat probe	6	8.12	Interrupting and continuing an operation	22
1.6	Steam cooking	6	8.13	Ending automatic oven cavity drying	22
1.7	Cleaning function	6	8.14	Opening and closing the control center	22
1.8	Proper installation and maintenance	6	8.15	Switching the interior lighting on or off	22
1.9	Remote operation	7	8.16	After each use	22
1.10	State of California Proposition 65 Warnings	7	8.17	Switching off the appliance	22
2	Preventing material damage	8	8.18	Switching on the appliance after automatic shut-off	22
2.1	General information	8	8.19	Displaying information	22
2.2	Steam	8	8.20	Displaying appliance information	22
2.3	Core temperature probe	8	8.21	Using the quick guides	22
2.4	Cleaning	9	9	Timer functions	22
3	Environmental protection and energy-saving	9	9.1	Overview of the timer functions	22
3.1	Disposal of packaging	9	9.2	Call up the timer menu	23
3.2	Saving energy	9	9.3	Exiting the timer menu	23
4	Familiarizing yourself with your appliance	9	9.4	Cooking time	23
4.1	Appliance	9	9.5	Cooking time end	23
4.2	Oven cavity	10	9.6	Count-up cooking timer	24
4.3	Interior lighting	10	10	Sabbath mode	24
4.4	Water tank	10	10.1	Opening the "Sabbath mode" function	24
4.5	Control elements	10	10.2	Selecting a time period for the "Sabbath mode" function	25
4.6	Types of heating	14	10.3	Selecting the settings for the interior lighting while the "Sabbath mode" function is active	25
4.7	Low power mode display	16	10.4	Setting heating cycles	25
4.8	Additional information	16	10.5	Changing the time period for the "Sabbath mode" function	25
4.9	Pop-up notifications	16	10.6	Changing settings for the interior lighting	25
4.10	Quick guides	16	10.7	Changing the heating cycle	25
4.11	Cooling fan	16	10.8	Deleting a heating cycle	26
4.12	Drying the oven cavity	17	10.9	Starting the "Sabbath mode" function	26
4.13	Automatic switch-off	17	10.10	Switching off the "Sabbath mode" function	26
4.14	Wipe protection	17	11	Manual door opening aid	26
4.15	Proximity sensor	17	11.1	Installing the manual door opening aid	26
4.16	Door lock	17	11.2	Opening the appliance door using the manual door opening aid	26
4.17	Steam removal	17	11.3	Cleaning the manual door opening aid	27
5	Functions in the Home Connect® app	17	11.4	Removing the manual door opening aid	27
6	Accessories	17	12	Child lock	27
6.1	Other accessories	18	12.1	Activating the childproof lock	27
6.2	Sliding accessories into the oven cavity	19	12.2	Deactivating the childproof lock	27
7	Before using for the first time	19	13	Favorites	27
7.1	Initial use	19	13.1	Creating the first favorites	27
8	Basic Operation	20	13.2	Selecting a favorite	27
8.1	Switching on the appliance	20	13.3	Renaming a favorite	27
8.2	Opening the appliance door	20			
8.3	Changing the type of heating	20			
8.4	Changing the temperature	20			
8.5	Displaying the current interior oven temperature	21			
8.6	Add broiler	21			

13.4	Starting a favorite	28	22.2	Rating plate location	52
13.5	Changing a favorite	28	23	Information regarding Free and Open Source Software	52
13.6	Deleting a favorite	28	24	STATEMENT OF LIMITED PRODUCT WARRANTY	53
14	Programs	28	24.1	What this warranty covers & Who it applies to	53
14.1	Automatic programs	28	24.2	How long the warranty lasts	53
14.2	Recommended settings	29	24.3	Repair/replace as your exclusive remedy	53
15	Core temperature sensor	30	24.4	Out of warranty product	53
15.1	Inserting the core temperature probe into the food	31	24.5	Warranty exclusions	53
15.2	Turning the food	31	24.6	Obtaining warranty service	54
15.3	Setting the core temperature probe	31	24.7	Product information	54
15.4	Deleting the set core temperature	32			
15.5	Changing the set core temperature	32			
15.6	Using the core temperature probe with the "Sous-vide cooking" type of heating	32			
15.7	Core temperature guideline values	32			
15.8	Estimated cooking time	33			
16	Home Connect®	33			
16.1	Setting up Home Connect®	33			
16.2	Home Connect® settings	34			
16.3	Starting functions with the Home Connect® app via manual "Remote start"	34			
16.4	Starting functions with the Home Connect® app via permanently activated "Remote start"	34			
16.5	Using the Home Connect® app to change settings	34			
16.6	Switching the Wi-Fi on or off	35			
16.7	Software update	35			
16.8	Data Protection	35			
17	Basic settings	35			
17.1	Overview of the basic settings	35			
17.2	Changing the basic settings	41			
18	Cleaning and maintenance	41			
18.1	Cleaning agents	41			
18.2	Microfiber cloth	42			
18.3	Cleaning the drain filter	42			
18.4	Cleaning aid	43			
18.5	Cleaning program	43			
18.6	Rapid drying	45			
18.7	Descaling program	46			
18.8	Removing the shelf supports	47			
18.9	Fitting the shelf supports	47			
19	Troubleshooting	47			
19.1	Malfunctions	48			
19.2	Display information	49			
19.3	Check the water tank	49			
19.4	Demo mode	49			
20	How it works	50			
20.1	General cooking tips	50			
20.2	Sous-vide cooking	50			
20.3	Preparing bulky food	51			
21	Transportation, storage and disposal	51			
21.1	Disposal of your old appliance	51			
22	Customer Service	52			
22.1	Model number (E-Nr.), production number (FD) and consecutive numbering (Z-Nr.)	52			



IMPORTANT SAFETY INSTRUCTIONS

READ AND SAVE THESE INSTRUCTIONS

Read all of the instructions carefully before using the appliance. In order to reduce the risk of fire, electric shocks and personal injuries when using the appliance, follow the basic safety precautions, including the following safety instructions.

1.1 Safety definitions

Here you can find explanations of the safety signal words used in this manual.

WARNING

This indicates that death or serious injuries may occur as a result of non-observance of this warning.

CAUTION

This indicates that minor or moderate injuries may occur as a result of non-observance of this warning.

NOTICE

This indicates that damage to the appliance or property may occur as a result of non-compliance with this advisory.

Note: This alerts you to important information.

1.2 General information

Here you can find general information about this manual.

- Please read this manual carefully.
- Observe the safety instructions and warnings.
- Keep the manual and the product information in a safe place for future reference or for the next owner.
- Check the appliance for damage after unpacking it. Do not connect the appliance if it has been damaged in transit.

This appliance is intended for use up to a maximum height of 13,100 feet (4000 meters) above sea level.

1.3 Safe use

WARNING

When properly cared for, your new appliance has been designed to be safe and reliable.

- ▶ Read all instructions carefully before use. These precautions will reduce the risk of burns, electric shock, fire, and injury to persons.
- ▶ When using kitchen appliances, basic safety precautions must be followed, including those in the following pages.

WARNING

While cooking food items, small amounts of certain by-products, such as particulate matter / soot, can be released. To minimize exposure to these substances:

- ▶ Always ensure proper ventilation by using an appropriate ventilation fan or hood vented to the outside and/or an open window.
- ▶ Always operate the unit according to the instructions in this manual.

WARNING

Overheated materials can cause fire or burns and may produce potentially harmful smoke or fumes.

- ▶ To prevent overheating, turn ventilation hood ON when heating grease, fats or frying using medium to high heat settings.
- ▶ Avoid heating empty pots and pans.
- ▶ Do not allow pans to boil dry.
- ▶ Do not allow aluminum foil, plastic, paper, or cloth to come in contact with a hot surface element, burner, or grate.

WARNING

If materials inside an oven or warming drawer should ignite, keep door closed.

- ▶ Turn off the appliance and disconnect the circuit at the circuit breaker box.

A fire could occur during cooking.

- ▶ Always have a working smoke detector near the kitchen.
- ▶ Have an appropriate fire extinguisher available, nearby, highly visible and easily accessible near the appliance.

NEVER cover any slots, holes or passages in the oven bottom or cover an entire rack with materials such as aluminum foil.

- ▶ Doing so blocks air flow through the oven.
- ▶ Aluminum foil linings may also trap heat, causing a fire hazard.

Cooking fires can spread if extinguished incorrectly.

- ▶ Never use water on cooking fires.

Wear Proper Apparel.

Loose-fitting or hanging garments, such as ties, scarves, jewelry, or dangling sleeves, should never be worn while using the appliance.

- ▶ Tie long hair so that it does not hang loose.
- ▶ Secure all loose garments, etc. before beginning.

In the event that personal clothing or hair catches fire, drop and roll immediately to extinguish flames.

Do Not Use Water on Grease Fires.

- ▶ Smother fire or flame or use dry chemical or foam-type extinguisher.

CAUTION

The oven vents are important for air circulation. Covering the oven vents will cause the oven to overheat. Refer to the appliance overview for the location of the oven vents.

- ▶ Do not obstruct oven vents.

WARNING

Use Only Dry Potholders - Moist or damp potholders on hot surfaces may result in burns from steam.

- ▶ Do not let potholders touch hot heating elements.
- ▶ Do not use a towel or other bulky cloth.

DO NOT TOUCH HEATING ELEMENTS OR INTERIOR SURFACES OF OVEN - Heating elements may be hot even though they are dark in color. Interior surfaces of an oven become hot enough to cause burns.

- ▶ During and after use, do not touch, or let clothing, potholders, or other flammable materials contact heating elements or interior surfaces of oven until they have had sufficient time to cool. Other surfaces



IMPORTANT SAFETY INSTRUCTIONS

READ AND SAVE THESE INSTRUCTIONS

of the appliance may become hot enough to cause burns. Among these surfaces are oven vent openings, surfaces near these openings and oven doors.

Use Care When Opening Door - Let hot air or steam escape before removing or replacing food.

- ▶ Standing to the side, open the door (or drawer) slowly and slightly to let hot air and/or steam escape.
- ▶ Keep your face clear of the opening and make sure there are no children or pets near the appliance.
- ▶ After the release of hot air and/or steam, proceed with your cooking.
- ▶ Keep doors shut unless necessary for cooking or cleaning purposes.
- ▶ Do not leave open doors unattended.

Do not clean the appliance while it is still hot. Some cleaners produce noxious fumes when applied to a hot surface. Wet clothes and sponges can cause burns from steam.

CAUTION

Use caution when cooking foods with high alcohol content (e.g. rum, brandy, bourbon) in the oven. Alcohol evaporates at high temperatures. There is a risk of burning as the alcohol vapors may catch fire in the oven.

- ▶ Use only small quantities of alcohol in foods, and open the oven door carefully.

Placement of Oven Racks - Always place oven racks in desired location while oven is cool. If the rack must be moved while the oven is hot, do not let potholders contact the hot heating elements in the oven. Use caution when removing oven racks from the lowest rack position to avoid contact with the hot oven door.

WARNING

Storage in or on Appliance - The use of corrosive chemicals in heating or cleaning will damage the appliance and could result in injury.

- ▶ Flammable materials, corrosive chemicals, vapors or non-food products should not be stored or used in an oven or on or near surface units.
- ▶ The appliance is specifically designed for use when heating or cooking food.

This appliance is intended for normal family household use only. It is not approved for outdoor use. See the Statement of Limited Product Warranty. If you have any questions, contact the manufacturer.

WARNING

Using this appliance other than for its intended use can cause fire or injury to persons.

- ▶ Use this appliance only for its intended use as described in this manual.
- ▶ NEVER use your appliances as a space heater for warming or heating the room. Doing so may result in overheating the appliance.
- ▶ Never use the appliance for storage.

WARNING

Do not heat or warm unopened food containers. Build-up of pressure may cause the container to burst and cause injury.

Failure to operate knobs properly may result in personal injury and damage to the appliance.

Cooking or roasting bags might explode.

- ▶ Follow the manufacturer's directions when using cooking or roasting bags.

CAUTION

To avoid possible injury or damage to the appliance, ensure oven rack is installed exactly per installation instructions and not backwards or upside down.

Do not place anything on the oven cavity bottom. Do not cover it with aluminum foil. A build-up of heat could damage the appliance or cause injury.

WARNING

Moisture intrusion may cause an electric shock.

- ▶ Do not use any steam cleaners or high-pressure cleaners to clean the appliance.

To avoid risk of injury from a damaged appliance or power cord, observe the following.

- ▶ Do not turn the power on if the appliance or the power cord is damaged. Doing so may cause injury.
- ▶ Never operate a damaged appliance.
- ▶ If the appliance or the power cord is damaged, immediately switch off the breaker in the circuit breaker box.
- ▶ Call Customer Service. → *Page 52*
- ▶ Repairs to the appliance should only be performed by an authorized service provider.

WARNING

Scratched glass in the appliance door may develop into a crack.

- ▶ Do not use any harsh or abrasive cleaners or sharp metal scrapers to clean the glass on the oven door, as they may scratch the surface.

CAUTION

To reduce the risk of contamination and damage:

- ▶ Always clean baking trays and wire racks before placing food on them.
- ▶ Inspect accessories for surface damage prior to use.

1.4 Child safety

This appliance is not intended for use by persons (including children) with reduced physical, sensory or mental capabilities, or lack of experience and knowledge, unless they have been given supervision or instruction concerning use of the appliance by a person responsible for their safety.

When children become old enough to use the appliance, it is the responsibility of the parents or legal guardians to ensure that they are instructed in safe practices by qualified persons.

Children should be supervised to ensure that they do not play with the appliance.



IMPORTANT SAFETY INSTRUCTIONS

READ AND SAVE THESE INSTRUCTIONS

WARNING

Do not allow children to use this appliance unless closely supervised by an adult.

- ▶ Children and pets should not be left alone or unattended in the area where the appliance is in use. They should never be allowed to play in its vicinity, whether or not the appliance is in use.

Do not allow anyone to climb, stand, lean, sit, or hang on any part of an appliance, especially a door, warming drawer, or storage drawer.

- ▶ This can damage the appliance, and the unit may tip over, potentially causing severe injury.

Do not let children play with the appliance.

CAUTION

Do not store items of interest to children in an appliance, in cabinets above an appliance or on the backguard of an appliance.

Children climbing on the appliance to reach items could be seriously injured.

Do Not Leave Children Alone.

- ▶ Children should not be left alone or unattended in the area where the appliance is in use.
- ▶ They should never be allowed to sit or stand on any part of the appliance.
- ▶ Always check inside the oven before turning it on.

WARNING

To avoid the risk of suffocation:

- ▶ Do not allow children to play with packaging material.
- ▶ Store small parts safely as they can be a choke hazard.

1.5 Safe use of the meat probe

WARNING

The oven interior and the meat probe become very hot.

- ▶ Use oven mitts to plug and unplug the meat probe.

WARNING

Use of a wrong meat probe can damage the insulation. Use only the meat probe intended for this appliance.

1.6 Steam cooking

Follow these additional safety instructions when using a steam cooking mode.

CAUTION

The water in the oven cavity is hot.

- ▶ Let the oven cavity cool down before you clean the appliance.

WARNING

Hot steam may escape when the appliance door is opened. Steam is not visible at certain temperatures!

- ▶ Open the appliance door carefully during or after cooking.
- ▶ Do not stand too near or lean over the appliance when opening the appliance door .

The water in the oven cavity becomes very hot during cooking.

- ▶ DO NOT clean the appliance immediately after switching it off.

- ▶ Wait until the appliance has cooled down.

Hot steam can leak during operation.

- ▶ Do not touch the ventilation openings.
- ▶ Keep children away.

Hot liquid may spill over the sides of cooking accessories when they are removed from the oven cavity.

- ▶ Carefully remove cooking accessories with oven mitts.

Movement when opening the appliance door and when removing the cookware can cause hot liquid to spray out.

- ▶ Do not stand too close to the appliance when opening it.
- ▶ Open appliance door carefully.
- ▶ Remove cookware carefully.
- ▶ Keep children away.

1.7 Cleaning function

Follow these safety instructions when using the cleaning function.

WARNING

To prevent the cleaner from coming into contact with the skin or eyes, do not remove the locking cap from a spent cartridge.

CAUTION

To avoid injury, do not remove the wax plugs from the opening of the cleaning cartridge. Do not use any other detergents. Do not use damaged cartridges.

WARNING

Do not use a protective coating to line the oven and do not use commercial oven cleaner.

Clean only parts listed in this manual.

1.8 Proper installation and maintenance

WARNING

In the event of a malfunction, it might become necessary to turn off the power supply.

- ▶ Have the installer show you the circuit breaker or fuse. Mark it for easy reference.

To avoid electrical shock hazard, before servicing the appliance, turn power off at the service panel and lock the panel to prevent the power from being switched on accidentally.

Proper Installation - Improper installation or grounding can cause electric shock.

- ▶ This appliance must be properly installed and grounded by a qualified technician.
- ▶ Connect only to properly grounded outlet.
- ▶ Refer to installation instructions for details.

User Servicing - Do not repair or replace any part of the appliance unless specifically recommended in this manual.

- ▶ All other servicing should be referred to an authorized service provider.

WARNING

Grease and fat can ignite when heated.

- ▶ Keep the oven free from grease build up.



IMPORTANT SAFETY INSTRUCTIONS

READ AND SAVE THESE INSTRUCTIONS

CAUTION

In the event of an error the display flashes and beeps continuously.

- ▶ Disconnect appliance from the power supply and call an authorized service provider.

WARNING

Malfunctions can cause injuries.

- ▶ Do not operate this appliance if it is not working properly, or if it has been damaged. Contact an authorized service provider.

1.9 Remote operation

CAUTION

This appliance may be configurable to allow remote operation at any time.

- ▶ Do not store any flammable materials or temperature sensitive items inside, on top or near surface units of the appliance.

1.10 State of California Proposition 65

Warnings

This product may contain a chemical known to the State of California, which can cause cancer or reproductive harm. Therefore, the packaging of your product may bear the following label as required by California:

STATE OF CALIFORNIA PROPOSITION 65 WARNING:



WARNING

Cancer and Reproductive Harm - www.P65Warnings.ca.gov

2 Preventing material damage

2.1 General information

NOTICE

A build-up of heat could damage the appliance.

- ▶ Do not place anything directly on the oven cavity floor.
- ▶ Do not line the oven cavity floor with aluminum foil.
- ▶ Always place cookware in a perforated cooking container or on a wire rack.

The appliance may become damaged due to the use of unsuitable liquids.

- ▶ Do not use any liquids other than water.
- ▶ Only use cold, fresh tap water, softened water or non-carbonated mineral water.
- ▶ You can obtain information about your mains water from your water supplier.

Chloride and acids may damage the stainless steel surface.

- ▶ Remove any residues of salt, hot sauces, e.g. ketchup or mustard, salted food, e.g. salted roasts, or other foods containing chloride or acid immediately.

If aluminum foil comes into contact with the door pane, it could cause permanent discoloration.

- ▶ Do not allow aluminum foil in the oven cavity to come into contact with the door pane.

Fruit juice can cause permanent stains in the oven cavity.

- ▶ Always remove fruit juice immediately.
- ▶ Wipe with a damp cloth, followed by a dry cloth.

The prolonged presence of moisture in the oven cavity leads to corrosion.

- ▶ Do not keep moist food in the closed oven cavity for extended periods of time.
- ▶ Do not store food in the oven cavity.

Rusting material may lead to corrosion in the oven cavity.

- ▶ Only use original accessories in the oven cavity.
- ▶ Do not use any enameled baking trays or grill trays.
- ▶ Never use serving plates or cutlery that may rust.

Small parts that are not original may damage the appliance.

- ▶ Only use original small parts, e.g. knurled nuts.
- ▶ If necessary, order small parts from our spare parts service.

Heat can damage stainless steel cooking containers.

- ▶ Only heat stainless steel cooking containers up to 445°F (230°C).
- ▶ Do not use stainless steel cooking containers in the oven.

Leaving the appliance to cool down with the door open will damage the front of adjacent units over time.

- ▶ Always allow the oven cavity to cool down with the door closed after cooking at high temperatures.
- ▶ Do not trap anything in the appliance door.
- ▶ Only leave the oven cavity to dry with the door open if a lot of moisture was produced during operation.

If the seal is very dirty, the appliance door will no longer close properly during operation. The fronts of adjacent units could be damaged.

- ▶ Always keep the seal clean.

- ▶ Never operate the appliance if the seal is damaged or missing.

Sitting or placing objects on the appliance door may damage it.

- ▶ Do not place, hang or support objects on the appliance door.
- ▶ Do not place any cookware or accessories on the appliance door.

Carrying the appliance by the appliance frame may cause it to bend. The appliance frame cannot support the weight of the appliance.

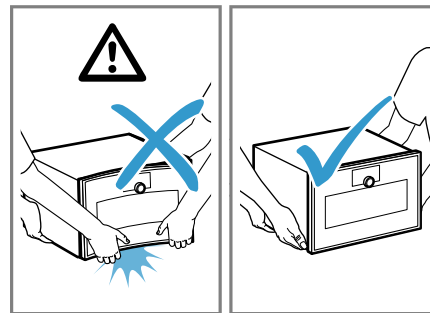

- ▶ Do not lift the appliance using the appliance frame.
- ▶ Always lift the appliance at the casing.

2.2 Steam

NOTICE

Dripping liquids may damage the oven cavity.

- ▶ To catch any dripping liquids, when steaming using a perforated cooking container, always insert the unperforated cooking container underneath.

Silicone baking molds are not suitable for combined operation with steam.

- ▶ Cookware must be heat- and steam-resistant.

Using cookware with rust spots may cause corrosion in the oven cavity. Even the smallest spots of rust can cause corrosion.

- ▶ Do not use cookware with rust spots.
- Hot water in the water tank may damage the steam system.

- ▶ Only fill the water tank with cold water.

If descaling solution comes into contact with the control panel or other delicate surfaces, it will damage them.

- ▶ Remove descaling solution immediately with water.

To avoid damage to the appliance or property damage, observe the following.

- ▶ Do not connect the appliance to the water line during construction or if the water appears cloudy or contains visible particles. Failure to follow these instructions may result in foreign materials entering the appliance, which could impair its performance, or cause water leakage.

2.3 Core temperature probe

WARNING

An incorrect core temperature probe may damage the insulation.

- ▶ Only use the core temperature probe that is suitable for this appliance.

NOTICE

Temperatures above 480°F (250°C) damage the core temperature probe.

- ▶ Only use the core temperature probe in your appliance at a maximum temperature of 445°F (230°C). You may damage the cable of the core temperature probe with the appliance door.

- ▶ Do not trap the cable of the core temperature probe in the appliance door.

The heat of the grilling surface may damage the core temperature probe.

- ▶ Ensure that the distance between the glass grilling surface and the core temperature probe and the cable of the core temperature probe is a few centimeters. In doing so, ensure that the meat can expand during the cooking process.

Aggressive cleaning agents may damage the core temperature probe.

- ▶ Do not clean the core temperature probe in the dishwasher.

2.4 Cleaning**NOTICE**

Limescale may damage the appliance.

- ▶ Descale the appliance regularly.

Using the wrong descaler may damage the appliance.

- ▶ Only use the specified descaling tablets.

Improper care of the appliance can lead to corrosion in the oven cavity.

- ▶ Follow the care and cleaning instructions for the appliance.

→ "Cleaning and maintenance", Page 41

- ▶ Clean the oven cavity each time you use it as soon as the appliance has cooled down.

- ▶ After cleaning the cooking compartment, use Rapid drying → Page 45 to dry it.

The descaling tablet may damage the oven cavity.

- ▶ Use the descaling tablet for the descaling program only.
- ▶ Place the descaling tablet into the water tank.
- ▶ Never place the descaling tablet in the oven cavity or heat it up in the oven cavity.

Heat may melt the cleaning cartridge and damage the oven cavity.

- ▶ Use cleaning cartridges for the cleaning program only.
- ▶ Never place cleaning cartridges in the oven cavity when it is hot or heat them up in the oven cavity.

Heat may damage the inserted cartridge.

- ▶ Never heat up the appliance if you have inserted the cartridge.

Heat damages the water tank.

- ▶ Do not dry the water tank in the hot oven cavity.

3 Environmental protection and energy-saving**3.1 Disposal of packaging**

The packaging materials are environmentally compatible and can be recycled.

- ▶ Sort the individual components by type and dispose of them separately.

3.2 Saving energy

If you follow these instructions, your appliance will use less power.

When steaming, you can cook on several levels at the same time.

- ✓ With steam, various dishes can be prepared at the same time without the different flavors mixing. When preparing dishes with different cooking times, those with the longest cooking time should be placed in the oven first.

When cooking multiple dishes, do so in succession or in parallel.

- ✓ The oven cavity is heated after cooking the first dish. This reduces the cooking time for the following dishes.

Use dark-colored or black-coated baking tins.

- ✓ These types of baking tin absorb the heat particularly well.

Open the appliance door as little as possible during operation.

- ✓ This maintains the temperature in the oven cavity and eliminates the need for the appliance to reheat.

Remove any accessories that are not being used from the oven cavity.

- ✓ Accessories that are not being used do not need to be heated.

Allow frozen food to defrost before cooking.

- ✓ This saves the energy that would otherwise be required to defrost it.

4 Familiarizing yourself with your appliance

This Use and Care Manual covers several models. Your model may have some but not all of the features listed.

4.1 Appliance

Here you can find an overview of the parts of your appliance.

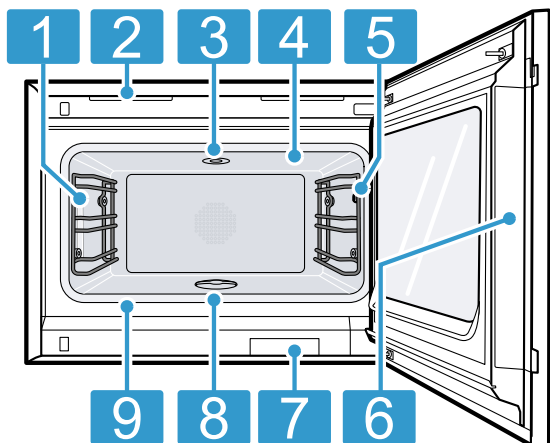

goods, you can also use two levels, e.g. level 1 and level 3.

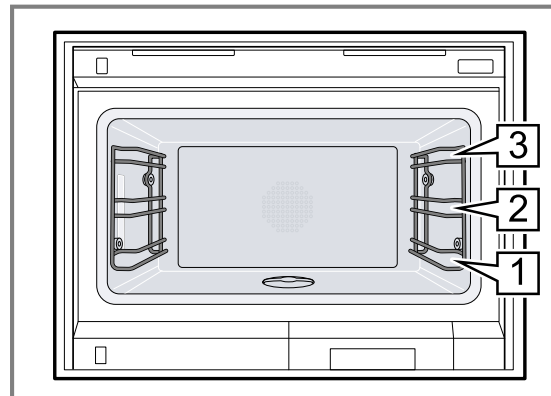

4.3 Interior lighting

When you open the appliance door, the interior lighting switches on. If the appliance door remains open for longer than around 3 minutes, the interior lighting switches off.

⚠ WARNING

The light emitted by LED lights is very dazzling, and can damage the eyes (risk group 1).

- ▶ Do not look directly into the switched on LED lights for longer than 100 seconds.

You can also switch on the interior lighting when the appliance is in low power mode.

After approximately 20 minutes, the appliance switches the interior lighting off.

When you switch on the appliance, the appliance switches the interior lighting on.

→ "Switching the interior lighting on or off", Page 22

In most operating modes, the appliance keeps the interior lighting switched on.

You can specify whether the appliance will switch the interior lighting on during operation in the basic settings → Page 35. If you select the "Manual" setting in the basic settings, the appliance does not switch on the interior lighting automatically but you can switch on the interior lighting when required. After approximately 20 seconds, the appliance switches the interior lighting off.

4.4 Water tank

Your appliance is equipped with a water tank for the descaling process, with a maximum capacity of 0.44 gallons (1.7 liters).

When you open the appliance door, you will see the water tank.

4.5 Control elements

You can use the control panel to configure all functions of your appliance and to obtain information about the operating status.

On certain models, specific details may differ from those pictured.

1	Interior lighting
2	Ventilation slots
3	Socket for cleaning cartridge
4	Broiling area
5	Connection socket for core temperature probe → Page 30
6	Intended area for opening the door
7	Water tank for descaling program
8	Drain filter
9	Door seal

4.2 Oven cavity

The cooking compartment has three shelf levels. Count the shelf levels from the bottom up.

NOTICE

A build-up of heat could damage the appliance.

- ▶ Ensure that the oven cavity floor always remains clear.
- ▶ Do not place anything directly on the oven cavity floor.
- ▶ Do not line the oven cavity floor with aluminum foil.
- ▶ Always place cookware in the perforated cooking container or on the wire rack.

The accessories may tip.

- ▶ Do not push the accessories between the shelf positions.

When steaming, defrosting, dough proving and reheating, you can use up to three shelf levels at a time. You can only bake on one level. Use level 2 for baking or, for taller baking tins, use level 1. For very small baked

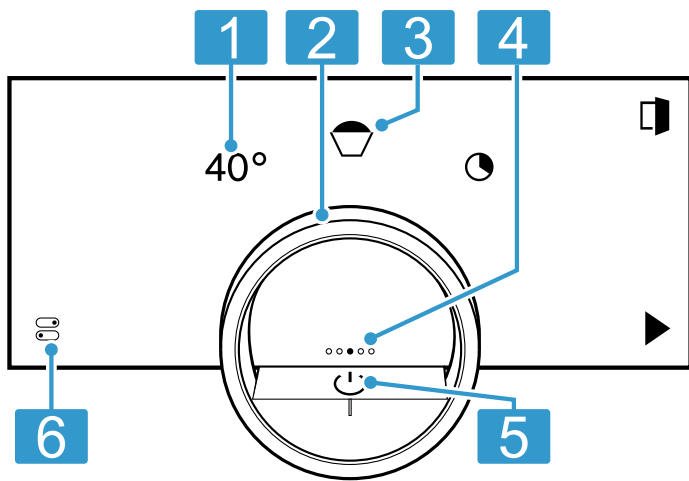

1	Symbols	Show settings, and start or end functions.
2	Control ring	Use the control ring to change the selection.
3	12 o'clock position	The 12 o'clock position shows the value that is currently selected for a function, which you can change using the control ring. If required, press on another function, e.g. on the temperature or cooking time, to position this at the 12 o'clock position.
4	Position indicator	The filled point on the display in the middle of the control ring shows the current horizontal navigation position between the appliance displays.
5	On/off button	Switch the appliance on and off.
6	Status bar & Control center	The status line shows the current status of functions or appliance components, e.g.: <ul style="list-style-type: none"> ▪ Home Connect® connection status ▪ Child protection ▪ Water tank fill level Press  to open the control center → <i>Page 14</i> .

Control ring

Operation using the control ring is only possible when the appliance is switched on. You can use the control ring to navigate through the ring menus or the list menus and select settings.

When you touch the control ring, the display shows a ring in orange behind the control ring.

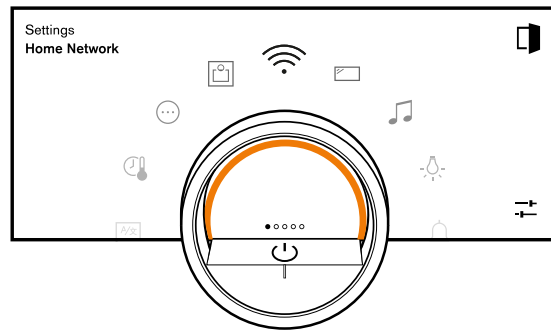

While operating the appliance, you can only use the control ring if you first select a function on the display.

Turn	Navigate in ring menus and list menus: <ul style="list-style-type: none"> ▪ Turn the control ring to the right to increase the values. ▪ Turn the control ring to the left to decrease the values. ▪ Turn the control ring to the right or left quickly to change the values in larger increments.
------	---

You can set how the control ring behaves in the basic settings → *Page 35*. In the "Standard" setting, press on the required function on the display and use the control ring to change the value of the function.

In the "Quick selection" setting, use the control ring, which is at the 12 o'clock position, to directly change the values for the function.

Process visualization

For process visualization, the appliance shows a section of a circle in orange behind the control ring.

The appliance shows the section of a circle in orange behind the control ring under the following conditions:

- A cooking time is set.
- A core temperature is set for the core temperature probe.

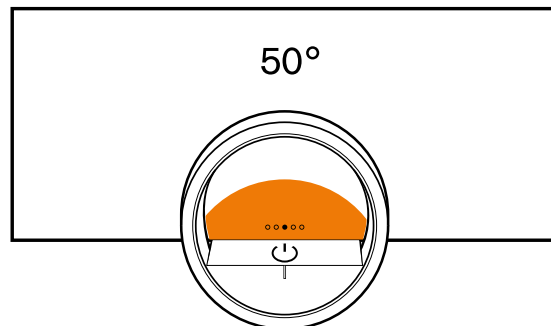

The section of the circle in orange becomes larger the longer the timer runs or the closer the core temperature of the food approaches the set core temperature. If no cooking time and no core temperature are set, the section of the circle pulsates in orange.

Display

The display shows the selected settings and setting options, as well as messages about the appliance's operating status.

Press	Selects or confirms the procedure or function
Press and hold	Displays additional information
Swipe horizontally	Navigates between appliance displays For example, in the "Manual" appliance display, swipe to the left or right Note: You can only use the function if you are in an appliance display and no program is running.

Note: If no display language is available in your national language, select a display language that is available, e.g. English.

Symbols

Use the symbols to start or stop functions, or to navigate in the appliance menu.

Operation

Symbol	Function
	Switch the appliance on or off at the control ring
	Opening the appliance door
	Open the control center → Page 22
	Edit settings
	Call up additional information → Page 22
	Save a favorite → "Favorites", Page 27
	Edit a favorite
	Deleting a favorite
	Tip for calling up programs → Page 28
	Start
	Pause or stop
	Switch to the next step
	Switch to the previous step
	Back or accept settings
	Next
	Confirm
	Delete
	Cancel
	Turning on the broiler
	Switching between the display for the preferred types of heating and the display of all available types of heating → "Basic settings", Page 35

Timer functions

Symbol	Function
	Call up the timer menu → Page 23
	Call up "Sabbath mode" → Page 24
	Deleting the heating cycle from "Sabbath mode" → Page 26
	Delaying the cooking time end → Page 24

Operation in the control center

Symbol	Function
	Opening the appliance door automatically after the cooking process
	Activate or deactivate the panel lock → Page 27
	Switch the interior lighting on or off → Page 22
	Start functions with the Home Connect® app via manual "Remote start" → "Starting functions with the Home Connect® app via manual 'Remote start'", Page 34
	Home Connect® Call up settings → "Home Connect® settings", Page 34

Cleaning and maintenance

Symbol	Function
	Cleaning aid → Page 43
	Cleaning program → Page 43
	Descaling program → Page 46
	Rapid drying → Page 45

Drying and misting

Symbol	Function
	Ending automatic cooking compartment drying
	Ending the automatic drying process
	Starting or ending misting
	Start condensation function → Page 21 or stop it early

Status

Symbol	Function
	Remote start → Page 34
	Core temperature probe is inserted → "Core temperature sensor", Page 30
	Core temperature probe is missing

Symbol	Function
	Status display for the heating process
	Display of a cooling process
	Pre-rinsing or post-rinsing
	Rapid drying → <i>Page 45</i> has started
	Appliance is in demo mode → <i>Page 49</i>

Status in the control center

Symbol	Function
	Connection to the router: Strong → <i>"Home Connect®", Page 33</i>

Symbol	Function
	Connection to the router: OK → <i>"Home Connect®", Page 33</i>
	Connection to the router: Weak → <i>"Home Connect®", Page 33</i>
	No connection to the router. → <i>"Home Connect®", Page 33</i>
	Appliance connected to the router. No connection to the Home Connect server. → <i>"Home Connect®", Page 33</i>
	Software update status

Appliance displays

You can find an overview of the appliance displays here.

Appliance displays	Use	Position indicator
Settings	<ul style="list-style-type: none"> Adjusting the basic settings → <i>Page 35</i> Adjusting the Home Connect® settings → <i>Page 33</i> 	●○○○○
Modes & Service	<ul style="list-style-type: none"> Starting the cleaning aid → <i>Page 43</i> Starting the cleaning program → <i>Page 43</i> Starting rapid drying → <i>Page 45</i> Starting the descaling program → <i>Page 46</i> Starting the quick guide → <i>Page 22</i> 	○●○○○
Manual operation	Setting the temperature, type of heating and timer function	○○●○○
Favorites	Calling up favorites → <i>Page 27</i>	○○○●○
Programs	Calling up automatic programs and recommended settings → <i>Page 28</i>	○○○○●

Tip: In the basic settings → *Page 35*, you can set which appliance menu your appliance starts in.

Colors

The different colors are used to guide the user in the relevant setting situations.

Red	<ul style="list-style-type: none"> Error messages for which you may need the help of customer service.
Orange	<ul style="list-style-type: none"> Information that you must observe so that you can continue to use your appliance Symbols for starting and stopping
White	<ul style="list-style-type: none"> Information Additional information

Appearance

Depending on the situation, the appearance of symbols, values or the entire display changes.

Zooming in ring menus and list menus	When you use the control ring to select a list entry in a list menu, the display enlarges this list entry and displays it as underlined.
--------------------------------------	--

Zoom at end of cooking or core temperature probe	When you use the control ring to select a value in a ring menu, the display shows this value enlarged in the 12 o'clock position. A few minutes before the cooking process ends, the appliance shows the remaining cooking time enlarged in the center of the display. As soon as the current core temperature is just a few degrees below the set value, the display shows the current core temperature enlarged. All other displays are hidden.
Pared-down display	If the appliance does not detect a user in the immediate vicinity, the appliance reduces the amount of information shown on the display and only the most im-

portant information remains. This function is pre-set. You can change the setting in the basic settings → Page 35.

You can activate or deactivate functions in the control center.

Control center



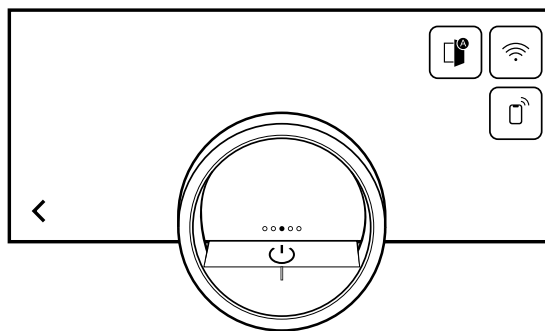

The control center  provides you with access to functions that are only visible in the status bar via symbols.















On the left-hand side, the display shows the symbols and texts with information on the current status of the appliance. On the right-hand side, the display shows the touch fields of the control center.

4.6 Types of heating

This is where you will find an overview of the types of heating. You will find recommendations for using the types of heating.

Symbols	Function/type of heating	Temperature/setting	Use
	Convection + 100% humidity	86-445°F (30-230°C)	Steaming at 158-212°F (70-100°C): The food is fully enveloped by steam and is gently cooked without being over-cooked. For vegetables, fish, seafood. Combi-operation at 300-445°F (150-230°C): The combination of hot air and steam guarantees a light and crispy result. For puff pastry, bread rolls.
	Convection + 80% humidity	86-445°F (30-230°C)	Combi-operation at 300-445°F (150-230°C): The combination of hot air and steam guarantees a juicy yet crispy result. For poultry and meals with little inherent moisture, such as bread, bread rolls.
	Convection + 60% humidity	86-445°F (30-230°C)	Combi-operation at 300-445°F (150-230°C): The combination of hot air and steam guarantees a juicy yet crispy result. For poultry and meals with a high level of moisture, such as bakes, lasagne.
	Convection + 30% humidity	86-445°F (30-230°C)	Combi-operation at 300-445°F (150-230°C): The inherent moisture of the meals is retained and they are prevented from drying out. For bakes, cakes.
	Convection + 0% humidity	86-445°F (30-230°C)	Hot air is distributed evenly and moisture can escape from the cooking compartment. For moist foods, such as fruit cake, quiches, bakes.

Symbols	Function/type of heating	Temperature/setting	Use
	Broil + circulated air	86-445°F (30-230°C)	Extremely intensive heat from above, which is distributed quickly and evenly by the fan. Guarantees that a crust is formed with simultaneous all-round heating. For meat, poultry, fish, vegetable skewers. No preheating is required.
	Broil level 1 + humidity	86-445°F (30-230°C)	Medium broiler output, combined with steam, guarantees that a crust is formed with simultaneous all-round heating. For bakes and gratins.
	Broil level 2 + humidity	86-445°F (30-230°C)	High broiler output, combined with steam, guarantees that a crust is formed with simultaneous all-round heating. For stuffed vegetables and poultry.
	Sous-vide cooking	122-204°F (50-95°C)	Highly precise steaming of vacuum-packed meals in the temperature range of 120-200°F (50-95°C). Nutrients and flavor are perfectly preserved. For meat, fish, vegetables, and desserts. The cooking temperature should only be 2-4°F (1-2°C) above the target core temperature. As a result, the cooking time is relatively long and, at the same time, it is almost impossible to over-cook the food. Meat and vegetables can be briefly seared after sous-vide cooking; it is preferable to sear fish before cooking it. With , you must pay attention to special food hygiene.
	Low-temperature cooking	86-194°F (30-90°C)	With this cooking method, meat is particularly soft and juicy, flavors are retained and even strengthened. Only season sparingly. Sear the meat briefly on all sides at a high heat in the frying pan before cooking it. This gives the meat a crust, which prevents the meat juices from escaping and produces the kind of flavor characteristic of a roast. The cooking temperature should only be 50-60°F (10-15°C) above the target core temperature. The more the interior temperature is reduced, the longer the cooking process takes. You can do this to control the cooking time end.
	Dough proofing	86-122°F (30-50°C)	Optimal climate at which the dough rises quickly without drying out. For yeast dough and sour-dough.
	Keeping warm	122-194°F (50-90°C)	Optimal climate for keeping food warm without it drying out.
	Defrosting	104-140°F (40-60°C)	Optimal climate for gently defrosting frozen food without it drying out. For roasts, fish, vegetables.

Symbols	Function/type of heating	Temperature/setting	Use
	Reheating	140-355°F (60-180°C)	For gently reheating cooked food. The steam ensures that the food does not dry out.
	Misting		Steam is let into the cooking compartment in order to increase the moisture.
	Condensation function		The steam is condensed by cold water so that only a little steam escapes when the door is opened. The function can be used at temperatures up to 266°F (130°C).
	Add broiler		The broiler is switched on for a few minutes in order to additionally brown the food. The function can be used at temperatures from 300°F (150°C)

4.7 Low power mode display

The appliance has different displays in low power mode. The displays depend on whether or not the appliance detects a user.

On the display without user detection, the appliance is switched off and the display is black. The appliance switches to low power mode without user detection if, when the appliance is switched on, you do not implement any settings for approx. 20 minutes or approx. 20 minutes after the appliance has completed a heating process.

If the proximity sensor detects a user or if you touch the control ring or press on the display, the appliance switches to low power mode with user detection.

In low power mode with user detection, the display shows the door opening symbol and the status bar. In the basic settings → *Page 35*, you can select whether the display also shows the GAGGENAU logo.

If the appliance is connected to the Home Connect® app, the display shows .

→ *"Home Connect®", Page 33*

The user detection distance depends on the selected basic settings.

In low power mode with user detection, the display brightness is reduced. The brightness of the display depends on the viewing angle.

When you press on , the display shows additional information about the current function.

When you press and hold certain symbols or values, the display shows additional information about the current function. Additional information is available for all symbols that are arranged around the control ring, e.g. information about the set type of heating or current interior oven temperature.

In the basic settings → *Page 35*, you can activate or deactivate the "Info-i" function.

The appliance also occasionally displays important information about safety and the operating status automatically. These messages disappear automatically after a few seconds, or when you press  to confirm the message.

For messages about Home Connect®, the appliance also displays the Home Connect® status.

→ *"Home Connect®", Page 33*

4.9 Pop-up notifications

Pop-up notifications contain explanations about current functions.

In the basic settings → *Page 35*, you can activate or deactivate the "Pop-up hints" function.

4.10 Quick guides

Your appliance comes with a quick guide to help you with various topics.

4.11 Cooling fan

The cooling fan switches on when the appliance is in operation. The hot air escapes above the door.

After removing your food from the appliance, keep the door closed until the appliance has cooled down. The appliance door must not be left half open as this may damage adjacent kitchen units. The cooling fan continues running for a certain period of time after the appliance has stopped heating and then it switches itself off automatically.

Do not cover the ventilation slots. Otherwise, the appliance may overheat.

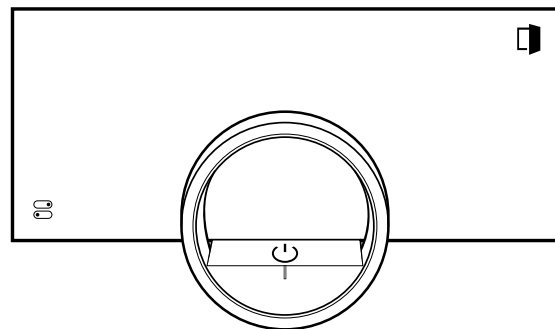

4.8 Additional information

If required, you can display additional information.

4.12 Drying the oven cavity

After operation with a steam function at temperatures of between 176 and 212°F (80 and 100°C), the cooling fan and the fan wheel on the back wall of the oven cavity continue to run for a while after the appliance is switched off and then they switch off automatically.

Automatic oven cavity drying does not start with cooking processes below 176°F (80°C).

After automatic oven cavity drying, the oven cavity may still contain moisture. The quick-drying function dries the oven cavity fully. If the oven cavity is very humid, we recommend you cancel the oven cavity drying process and run a quick-drying process instead, which takes approx. 15 minutes.

After certain cooking processes, the oven cavity drying process may take up to 95 minutes. Keep the appliance door closed while the oven cavity is being dried.

If automatic oven cavity drying does not start or there is still too much moisture in the oven cavity after oven cavity drying, start the quick-drying process. → *Page 45*

4.13 Automatic switch-off

For your protection, the appliance is equipped with an automatic shut-off function. The appliance switches off the heating process after 12 hours if you do not operate the appliance or program a cooking time during this time. The display shows a message.

If you set a cooking time, you can use the appliance for longer.

If you set a cooking time, you can operate the appliance in the "Sous-vide cooking" type of heating for a maximum of 72 hours.

When programming with the "Sabbath mode" function, the appliance switches off after up to 74 hours.

4.14 Wipe protection

Your appliance detects if you would like to clean the display or navigate between the appliance displays. The appliance locks the operation via the display and the control ring for a short time.

Press the display to return to the operation.



4.15 Proximity sensor

Your appliance detects whether you are in front of the appliance or moving towards it. Your appliance disregards if you are passing in front of it.

If you do not remain in the detection zone for the appliance when it is switched on, the appliance reduces the display to what is essential.

Note: You can set the distance at which the appliance can detect you in the basic settings. To ensure that the proximity sensor optimally detects the user, set the installation height of the appliance's upper edge in the basic settings → *Page 35*.

4.16 Door lock





The "Door lock" function prevents the appliance door from being opened accidentally. This is particularly useful when installing the appliance under the countertop. In the basic settings → *Page 35*, you can activate or deactivate the "Door lock" function. When you activate the function and press , the display shows a slide control instead of the  symbol.

4.17 Steam removal

During the steam removal process, the appliance introduces cold water into the oven cavity. The steam condenses on the oven cavity wall and the oven cavity cools down.

If you open the appliance door after steam removal, only a little steam escapes.

Steam removal only works with the following types of heating and if the temperature in the oven cavity is below 265°F (130°C):

- "Convection + 100% humidity" 
- "Convection + 80% humidity" 
- "Convection + 60% humidity" 
- "Sous-vide cooking" 

The appliance carries out steam removal automatically at the end of an automatic program → *Page 28* or a timed program (cooking time → *Page 23*).

5 Functions in the Home Connect® app

The Home Connect® app offers a range of functions and benefits.

- Monitor the cooking process, e.g. the remaining cooking time or the current core temperature.
- Start or stop a type of heating or program, or change the settings.
- Run important updates to the appliance software.



- Find the optimum settings or the optimum program for your recipe with the Oven Assistant function.
- View the estimated remaining cooking time when using the core temperature probe.
- Change the basic settings for the appliance.
- Operate the main functions via Voice Control (using Alexa or Google Home).
- Find the appliance information and instructions.
- Find new recipes.

6 Accessories

Only use genuine accessories. These are designed especially for your appliance.

Note: Accessories may become deformed if they get hot. Deformation has no effect on function. As the accessory cools down, it will regain its original shape.

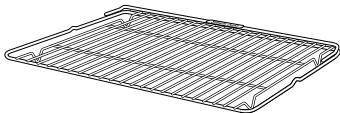
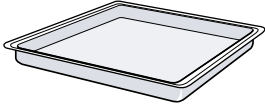
The accessories supplied may differ depending on the appliance model.

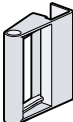
Accessories		Use
Wire rack		<ul style="list-style-type: none"> ▪ Cookware ▪ Cake tins ▪ Ovenproof dishes ▪ Roaster <p>Note: Only use the combi-steam oven pan support in the combi-steam oven and not in the oven or microwave. The pan support may become discolored at temperatures above 250 °C. The pan support for the combi-steam oven is labeled with lettering.</p>
Stainless steel cooking container, unperforated		<ul style="list-style-type: none"> ▪ Cooking rice, cereals, and legumes ▪ Catching dripping liquid during steaming and defrosting
Stainless steel cooking container, perforated		<ul style="list-style-type: none"> ▪ Steaming vegetables and fish ▪ Extracting juice from berries ▪ Defrosting
Cleaning cartridge		Cleaning the oven cavity with the cleaning program → <i>Page 43</i>
Manual door opening aid		Open the door without using the automatic door opening button, e.g. on the Sabbath.

6.1 Other accessories

You can purchase other accessories from our Customer Service, specialist retailers or online.

You will find a comprehensive range of products for your appliance in our brochures and online:

www.gaggenau.com

Accessories are appliance-specific. When purchasing, always check for compatibility with your appliance model number (E-Nr).

You can find out which accessories are available for your appliance in our online shop or from our Customer Service.

Other accessories	Order number
Full extension drawer	BA010301
Core temperature sensor	BA010050
Stainless steel cooking container, perforated	BA020370
Stainless steel cooking container, unperforated	BA020361

Cooking container, non-stick, perforated

NOTICE

Intense heat damages non-stick cooking containers.

- ▶ Only heat non-stick cooking containers up to 445 °F (230 °C).
- ▶ Use non-stick cooking containers only in the combi-steam oven.

- Order number
- BA020381

Cooking container, non-stick, perforated

NOTICE

Intense heat damages non-stick cooking containers.

- ▶ Only heat non-stick cooking containers up to 445 °F (230 °C).
- ▶ Use non-stick cooking containers only in the combi-steam oven.

- Order number
- BA020381

Other accessories	Order number
Glass tray	BA046118
Set with 4 descaling tablets	17002490
Set with 4 cleaning cartridges	CLS10040
GN adapter, for use with GN cooking inserts and roasters	GN010330
Stainless steel cooking container, GN 1/3, perforated, 1½" deep, 0.4 gal (40 mm, 1.5 l)	GN124130
Stainless steel cooking container, GN 1/3, unperforated, 1½" deep, 0.4 gal (40 mm, 1.5 l)	GN114130
Stainless steel cooking container, GN 2/3, perforated, 1½" deep, 0.8 gal (40 mm, 3 l)	GN124230

Other accessories	Order number
Stainless steel cooking container, GN 2/3, unperforated, 1½" deep, 0.8 gal (40 mm, 3 l)	GN114230
Cast aluminum roaster	GN340230
Manual door-opening aid	10044742

6.2 Sliding accessories into the oven cavity

The wire rack and the perforated cooking container are equipped with a locking function. For the tilt protection to work correctly, always insert the wire rack and the perforated cooking container into the oven cavity the right way round. The locking function is not available for the unperforated cooking tray.

NOTICE

The accessories may tip.

- ▶ Do not push the accessories between the shelf positions.

The oven's wire rack is not suitable for the combi-steam oven.

Corrosion may form on the oven's wire rack.

- ▶ Do not use the oven's wire rack in the combi-steam oven.

1. When inserting the wire rack, ensure that the lug  is facing upwards.

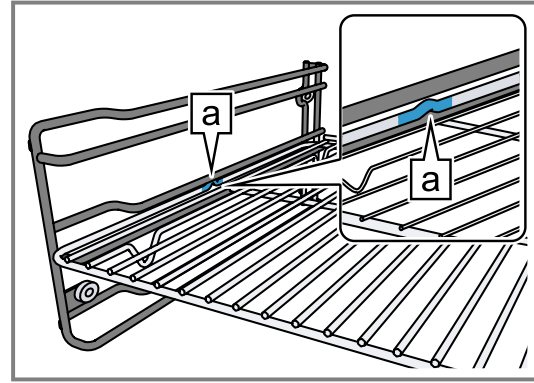

2. Ensure that the safety bracket on the wire rack is located at the rear and is facing upwards.
3. When inserting the cooking container, ensure that the lug  is facing upwards.

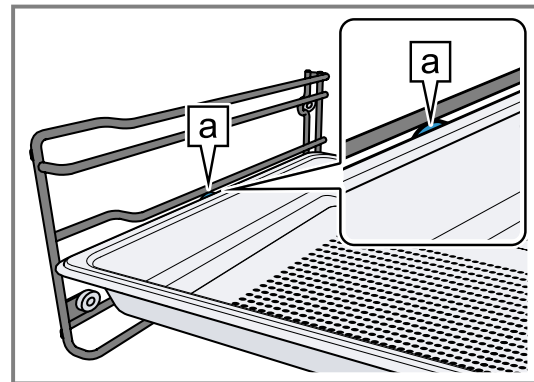

The locking function prevents the accessories from tilting when they are pulled out.

Note: To completely pull out the accessories, lift them slightly.

Remove any accessories that you do not require from the oven cavity.

7 Before using for the first time

Apply the initial configuration settings. Clean the appliance and the accessories.

7.1 Initial use

Implement the settings for initial use before using your appliance.

First read the information under Safety.

The appliance must be installed and connected.

After connecting to the power supply, the appliance shows the "Initialization" display.

The appliance shows the "Initialization" display when it is first switched on after being connected to the power supply, if the initial start-up has not been completed successfully or the appliance has been restored to the factory settings.

Implement the following settings:

- Setting the language
- Activating Home Connect®
- Set the temperature unit
- Set the weight unit

- Setting the time format
- Set the time

You can retroactively change all of the settings in the basic settings → *Page 35*.

Follow the instructions in the display. The display guides you through the initial settings.

Setting the language and implementing the remaining settings

1. Press .
- ✓ The display shows the preset language.
2. Use the control ring to select the required display language.
3. Press ✓ to confirm.
4. Press →.
5. Implement the remaining settings.
- ✓ The appliance starts a rinsing process.
- ✓ The display shows the appliance display that is selected in the basic settings → *Page 35* as the start screen.

Cleaning the door pane

Note: To ensure tightness, the door seal is lubricated at the factory. Residue may remain on the door pane.

- ▶ Before using for the first time, clean the door pane with glass cleaner and a window cloth or a microfiber cloth.
- Do not use a glass scraper.

Cleaning the accessories

- ▶ Before first use, clean the accessories thoroughly using hot soapy water and a soft cloth.

Heating up the appliance

1. Ensure that there is no leftover packaging in the oven cavity.
2. Remove any accessories from the oven cavity.
3. To eliminate the new-appliance smell, heat up the empty appliance with the door closed.
The ideal setting for heating is 390°F (200°C) in the Hot air + 60% humidity $\frac{4}{5}$ type of heating for one hour.
4. Clean the appliance interior.

8 Basic Operation

8.1 Switching on the appliance

1. To exit low power mode → *Page 16*, press \odot on the appliance's control ring or in the Home Connect® app.
 - ✓ The display shows a temperature, a symbol for the type of heating, and a symbol for the timer.
 - ✓ The appliance switches the interior lighting on.
 - ✓ \odot lights up orange.
2. Set the temperature, type of heating and cooking time that you require.

Tip: In the basic settings → *Page 35*, you can specify which appliance display appears on the display after the appliance is switched on and whether you want the interior lighting to switch on.

Note: If you do not implement any settings for an extended period, the display shows the appliance display that is selected in the basic settings → *Page 35* as the start screen, and then the low power mode display.

8.2 Opening the appliance door

⚠ WARNING

The inside of the appliance door becomes very hot during operation.

- ▶ During or after operation of the appliance, only touch the appliance door at the surface intended for this on the side.
- ▶ Always open the appliance door as far as it will go.
- ▶ Ensure that the appliance door does not swing back.

⚠ WARNING

Hot steam may escape when you open the appliance door. Steam may not be visible, depending on the temperature.

- ▶ Open the appliance door carefully.
- ▶ Keep children away from the appliance.

1. Press \square .
 - ▶ If the "Door lock" function is activated in the basic settings → *Page 35*, move the slide control to the other end.
 - ✓ The appliance door opens automatically.

2. Only touch the appliance door at the designated area \square and open it fully.

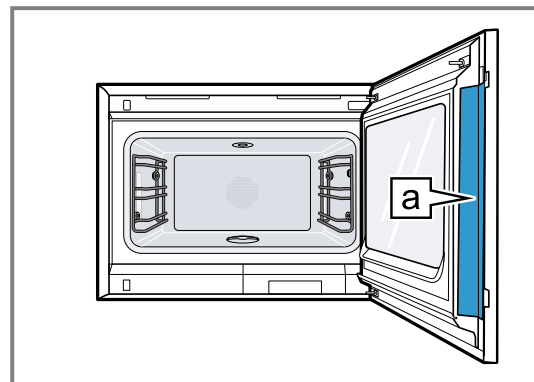

Tip: In the control center, you can set that the appliance door opens automatically after the current cooking process.

8.3 Changing the type of heating

Note: You can change the type of heating during operation.

1. Press the current symbol for the type of heating.
2. Use the control ring to select the required type of heating.
3. Press on the selected type of heating or \leftarrow , or wait a few seconds.
 - ✓ The display shows the selected type of heating and the suggested temperature.
 - ✓ If you have previously used the type of heating, the display shows the last temperature that you used.
4. If required, change the temperature. → *Page 20*
5. If the display shows a notification window, follow the instructions in the notification window.
6. Press \blacktriangleright to start the operation.

8.4 Changing the temperature

Note: You can change the temperature during operation.

Requirement: The type of heating is selected.

→ "Changing the type of heating", *Page 20*

1. Press the temperature displayed.

2. Use the control ring to select the desired temperature.
- ✓ The display shows the temperatures that are available for the selected type of heating.
3. To change the previously stored appliance display, press the required temperature or <. If you do not use the appliance for an extended period, the display returns to the previously stored appliance display.
- ✓ The display shows the selected temperature.

Note: Once the operation has started, the display shows a progress bar below the selected temperature if the changed temperature is more than 20 °C higher than the previous temperature.

8.5 Displaying the current interior oven temperature

- ▶ Press and hold the set temperature.
- ✓ The display shows the current interior oven temperature.

Note: During continuous operation after heating up, slight temperature fluctuations are normal.



8.6 Add broiler

You can brown or gratinate your food using the broiler. The "Add broiler" function is available for the "Convection + 100% humidity", "Convection + 80% humidity", "Convection + 60% humidity", "Convection + 30% humidity" and "Convection + 0% humidity" type of heating. The "Add broiler" function is not available until a temperature of 150 °C is reached.

Turning on the broiler



NOTICE

Temperatures above 480 °F (250 °C) damage the core temperature probe.

- ▶ If you use the core temperature probe, never place the food on the top shelf level.
1. Use the control ring to select the required type of heating and start the operation. The "Add broiler" function is not available for all types of heating.
 2. Press .
 - ✓  lights up.
 - ✓ The appliance switches the grill off for approx. 3 minutes.

Deactivating the broiler



Requirement:  lights up orange.

- ▶ Press .
- ✓  lights up white.
- ✓ The broiler is deactivated.

8.7 Steam injection



With the "Misting" function, the appliance brings steam specifically into the oven cavity. This enables you to bake food such as bread and bread rolls with sufficient moisture. It also gives yeast-risen baked goods a smooth, shiny crust.

The "Misting" function is available for the following types of heating only:

- "Convection + 30% humidity" 
- "Convection + 0% humidity" 
- "Broil + circulated air" 

Note: For best results, activate the function at the beginning of the cooking process.

Starting steam injection

- ▶ Press .
- ✓  lights up.
- ✓ After a short time, the appliance injects steam into the oven cavity.
- ✓ The appliance ends the misting automatically after approximately 5 minutes.

Canceling steam injection

- ▶ Press .

8.8 Starting steam removal

The steam removal function only works with the "Convection + 100% humidity", "Convection + 80% humidity", "Convection + 60% humidity" and "Sous-vide cooking" type of heating.

Requirement: The cooking compartment temperature is below 130 °C.

- ▶ Press .
- Steam removal takes approximately 25 seconds. During steam removal, the heater is switched off.

8.9 Stopping steam removal early

- ▶ Press .

8.10 Opening the appliance door automatically after the cooking process



The "automatic door opening" function at the end of the cooking process is only valid for the current cooking process.

WARNING

The appliance and its parts that can be touched become hot during use.



- ▶ Young children under 8 years of age must be kept away from the appliance.
- ▶ Ensure that young children are not in the vicinity of the appliance when the appliance door opens automatically.

Note: Use the "automatic door opening" function at the end of the cooking process only if required to prevent the food from being overcooked or burning. In order to reduce the amount of moisture deposited on the unit fronts, open the appliance door fully after the cooking time has elapsed if possible.



1. Press .
2. Press .
- ✓ The display shows .
- ✓ The appliance opens the appliance door automatically after the current cooking process with a set cooking time end or set core temperature.

Note: The appliance door also opens when the child lock → *Page 27* is activated or the door lock → *Page 17* is activated.

8.11 Deactivating automatic appliance door opening

1. Press .
2. Press .
- ✓ The display shows .
- ✓ Automatic appliance door opening after the cooking process is deactivated.



8.12 Interrupting and continuing an operation

1. To interrupt the operation, press .
2. To continue the operation, press .

8.13 Ending automatic oven cavity drying

Note: When you open the appliance door, the appliance interrupts the automatic oven cavity drying process.

Requirement: In the control center, the display shows .



1. Press .
2. Press .
- ✓ The appliance ends the automatic oven cavity drying process.

Tip: Under "Modes & Service", you can start the "Rapid drying" function at any time.

8.14 Opening and closing the control center

1. Press .
- ✓ The appliance shows a description above the functions currently active.
2. To activate or deactivate a function as required, press the symbol for the function.
3. Press < to close the control center.
- ✓ A pop-up message → *Page 16* tells you if a function has been activated.

8.15 Switching the interior lighting on or off

1. Press .
2. Press .

8.16 After each use

Dry the cooking compartment to ensure that no moisture remains in the appliance and to prevent odor from building up.

WARNING

Hot steam may escape when you open the appliance door. Steam may not be visible, depending on the temperature.

- ▶ Open the appliance door carefully.

- ▶ Keep children away from the appliance.

Drying the oven cavity

1. Remove food residues and/or dirt from the oven cavity as soon as the appliance has cooled down. Burnt-on food residue and/or dirt will be much harder to remove later.
2. Once the cooking compartment has cooled down, wipe it out and dry it thoroughly with a soft cloth.
3. If necessary, wipe dry any condensation on units or handles.
4. If required, you can use the function to quickly dry the cooking compartment.
→ "Rapid drying", *Page 45*

8.17 Switching off the appliance

- ▶ Press  on the control ring.
Depending on the type of heating, you may hear an automatic rinse cycle running.
- ✓ The appliance switches to low power mode.

8.18 Switching on the appliance after automatic shut-off

Requirement: After prolonged operation, the automatic shut-off → *Page 17* switches off the appliance.

- ▶ Press  on the control ring.

8.19 Displaying information

- ▶ Press .
- ✓ The appliance displays information about the selected function.
→ "Additional information", *Page 16*

8.20 Displaying appliance information

1. Swipe repeatedly from left to right until the display shows "Modes & Service".
- ✓ The display shows the available functions in a list menu.
2. Use the control ring to select the "Appliance information" function.
3. Press "Appliance information".
- ✓ The display shows the appliance information, e.g. the E-number and the serial number.
4. Press < to exit the display.

8.21 Using the quick guides



1. Select the "Modes & Service" appliance display.
2. Use the control ring to select "Quick guide", then release the control ring.
3. Select the required quick guide and view it.

9 Timer functions

Your appliance has different timer functions, with which you can control its operation.

9.1 Overview of the timer functions

Use  to select the different timer functions.

Timer function	Usage
	Cooking time
	Cooking time end

A cooking time or cooking time end can only be set in combination with a type of heating.

The "Cooking time" and "Core temperature probe" functions are not available at the same time.

9.2 Call up the timer menu

- ▶ Press .
- ✓ The display shows "h" and "min" for hours and minutes.
- ✓ The display shows the display for the minutes enlarged in the 12 o'clock position.

9.3 Exiting the timer menu

- ▶ Press < or press on the selected cooking time to switch to the previously stored appliance display.
- ✓ The timer menu is closed.

9.4 Cooking time

When you set the cooking time for your food, the appliance automatically switches off after this time. The maximum possible cooking time depends on the set type of heating.

For most types of heating, you can set a cooking time of 1 minute up to 24 hours.

For the "Sous-vide cooking" and "Drying" types of heating, the maximum cooking time is 72 hours.

You can change the type of heating and temperature while the cooking time counts down.

Setting the cooking time

Requirement: No core temperature is set. You cannot use the "Cooking time" and "Core temperature probe" functions at the same time.

1. Place the food in the oven cavity.
2. Press .
- ✓ The display shows h : min for hours and minutes.
3. Press the required value and use the control ring to change the value.
 - ▶ Turn the control ring slowly to change the value in smaller increments.
 - ▶ Turn the control ring quickly to change the value in greater increments.

The maximum possible cooking time depends on the type of heating.

- ✓ The appliance automatically calculates the time for the cooking time end.
- 4. Press < or press on the selected cooking time to switch to the previously stored appliance display. If you do not use the appliance for an extended period, the appliance saves the settings and the display returns to the previously stored appliance display.
- ✓ If the appliance is in operation, the appliance shows the temperature, the operating mode, and the remaining cooking time.
- ✓ 3 minutes before the end of the cooking time, the display zooms in on the remaining cooking time.
- ✓ After the cooking time has elapsed, the display shows 00:00 and a signal tone sounds.

5. Turn the control ring or open the appliance door. The appliance door opens automatically if you have activated this function.
- ✓ The signal tone stops.

Note: If there is no further operation following the signal tone, the display shows the "Downtime timer" function with the + symbol. The display shows how much time has elapsed since the cooking time ended. After approx. 20 minutes without any further operation, the appliance switches to low power mode.

Changing the cooking time

Requirement: You have set a type of heating and a temperature.

1. Press .
- ✓ The display shows h : min for hours and minutes.
2. Press the required value and use C to delete the value, or use the control ring to change the value.
 - ▶ Turn the control ring slowly to change the value in smaller increments.
 - ▶ Turn the control ring quickly to change the value in greater increments.

The maximum possible cooking time depends on the type of heating.

- ✓ The appliance automatically calculates the time for the cooking time end.
- 3. Press < or press on the selected cooking time to switch to the previously stored appliance display. If you do not use the appliance for an extended period, the display returns to the previously stored appliance display.
- ✓ The display shows the temperature, the type of heating, the remaining cooking time, and the cooking time end.

Deleting the cooking time

Tip: In the "Manual" appliance display, double-click on the cooking time in order to delete the cooking time without switching to the timer settings.

1. Press .
- ✓ The display shows h : min for hours and minutes.
2. Press the required value and use C to delete the value.
 - ✓ The display shows --:--.
3. Press < or press on the selected cooking time to switch to the previously stored appliance display. If you do not use the appliance for an extended period, the display returns to the previously stored appliance display.
- ✓ The display does not show a cooking time.

9.5 Cooking time end

As soon as you set a cooking time, the display shows the cooking time end. You can delay the cooking time end by a maximum of 12 hours.

For example, if you set a cooking time of 90 minutes at 10 a.m., you can delay the end of the cooking time so that the cooking process ends at 11.30 p.m. at the latest.

For most types of heating, the maximum cooking time is 24 hours.



For the "Sous-vide cooking" and "Drying" types of heating, the maximum cooking time is 72 hours.

With the "Sous-vide cooking" type of heating, it is not possible to postpone the end of the cooking time for hygiene reasons.

Bear in mind that food which spoils easily should not be left in the appliance for too long.

Delaying the cooking time end

Requirement: No core temperature is set. You cannot use the "Cooking time" and "Core temperature probe" functions at the same time.



1. Place the food in the oven cavity.
2. Press .
 - ✓ The display shows h : min for hours and minutes.
3. Set the cooking time. → *Page 23*
 - ✓ The appliance automatically calculates the time for the cooking time end.
4. Press < or press on the selected cooking time to switch to the previously stored appliance display. If you do not use the appliance for an extended period, the display returns to the previously stored appliance display.
5. Press on the cooking time end.
6. Use the control ring to set the required cooking time end.
7. Press .
 - ✓ The appliance switches to standby.
 - ✓ The display shows the temperature, the type of heating, and the cooking time end.
 - ✓ If the end of cooking time is one or more days in the future, the display shows "+1d".
 - ✓ The appliance starts at the calculated time and automatically switches off once the cooking time has elapsed.
 - ✓ After the cooking time has elapsed, the display shows 00:00 and a signal tone sounds.
8. Turn the control ring or open the appliance door. The appliance door opens automatically if you have activated this function.
 - ✓ The signal tone stops.

Note: If there is no further operation following the signal tone, the display shows the "Downtime timer" function with the + symbol. The display shows how much time has elapsed since the cooking time ended. After approx. 20 minutes without any further operation, the appliance switches to low power mode.

Resetting the delay of the cooking time end

Note: In the "Manual" appliance display, double-click on the cooking time end in order to reset the delay of the cooking time end without switching to the timer settings.

Requirement: You have used the control ring to manually set the cooking time end.



1. Press .
2. To reset the delay of the cooking time, press .
 - ✓ The appliance calculates the cooking time end based on the cooking time.
 - ✓ The display shows the cooking time end.
3. Press < or press on the cooking time end to switch to the previously stored appliance display. If you do not use the appliance for an extended period, the display returns to the previously stored appliance display.

9.6 Count-up cooking timer

If no cooking time is set, the display shows the time that has elapsed since the start of the process.

In the basic settings, you can switch the "Count-up cooking timer" function on or off.

Reset "Count-up cooking timer"

1. Press and hold .
2. Press .
 - ✓ The "Count-up cooking timer" function is reset.

10 Sabbath mode

You can use this function to keep food warm and cook food for up to 74 hours without having to switch the appliance on or off. You can select the "Convection" type of heating, temperature, and the required cooking time. Bear in mind that food which spoils easily should not be left in the appliance for too long.

You can use the "Sabbath mode" function to program 9 different heating cycles with a total cooking time of 74 hours. Set a start time and an end time. The display shows which settings have been selected.

You can define whether the interior lighting is switched on or switched off during the selected cooking time. At the end of the selected cooking time, the appliance automatically deactivates the function. If required, you can deactivate the "Sabbath mode" function at any time using the on/off button .

If the "Sabbath mode" function is active, the display screen does not change when you approach the appliance.

If the "Sabbath mode" function is active, you cannot operate the appliance via the display and the control ring

and you can only open the door manually using the manual door opening aid. Install the manual door opening aid before the Sabbath.

If the "Sabbath mode" function is active, the "Automatic door opening at the end of the cooking process" function is not available.

If the "Sabbath mode" function is active and you open the appliance door, the appliance ends the heating operation after a randomly selected time of approx. 20 to 30 seconds. If you close the appliance door again, the appliance starts the heating operation after a randomly selected time of approx. 20 to 30 seconds. To avoid interrupting the heating operation, only open the appliance door between two heating operations.

10.1 Opening the "Sabbath mode" function

Requirement: The "Sabbath mode" function is set to "On" in the basic settings → *Page 35*.

1. Swipe repeatedly from left to right until the display shows "Modes & Service".

2. Use the control ring to select the "Sabbath mode" function.
3. Set the switch to the right of the "Sabbath mode" list entry to "On".
- ✓ The display shows the start time and the end time.

10.2 Selecting a time period for the "Sabbath mode" function

Requirement: The "Sabbath mode" function is set to "On" in the basic settings → *Page 35*.

1. Press the start time.
2. Use the control ring to change the start time.
3. Press <.
- ✓ The appliance automatically calculates the time for the end time.
- ✓ The display shows the start time and the end time.
4. Press the end time.
5. Use the control ring to change the end time.
- ✓ The display shows the start time and the end time.
6. Press ✓ to confirm.
- ✓ The display shows Ⓞ.

Note: If you set a delayed start time for the "Sabbath mode" function, you can only start cooking processes with a programmed end time.

The following functions are not available:

- Cleaning programs
- Some cooking programs
- Cooking processes with a set core temperature
- Cooking processes without a cooking time end

10.3 Selecting the settings for the interior lighting while the "Sabbath mode" function is active

Requirement: A start time and an end time are selected.

→ *"Selecting a time period for the Sabbath mode function", Page 25*

1. Press →.
2. To switch the interior lighting on at the lowest lighting level for the entire cooking time while the "Sabbath mode" function is active, set the switch for the interior lighting to "On".
3. To switch the interior lighting off for the entire cooking time while the "Sabbath mode" function is active, set the switch for the interior lighting to "Off".
- ✓ The display shows the start time and the end time.
4. To program the first heating cycle, if needed, press +.
→ *"Setting heating cycles", Page 25*

10.4 Setting heating cycles

1. Press Ⓞ.
- ✓ The display shows the settings that have been selected for the "Sabbath mode" function.
2. Press "Summary".
3. Press <.
4. Press +.
5. Press the temperature to set it.
 - ▶ Use the control ring to select the required temperature and press <.
6. To change the start time, press the start time.
 - ▶ Use the control ring to change the start time and press <.

7. To change the end time, press the end time.
 - ▶ Use the control ring to change the end time and press <.
- ✓ The display shows the settings for the first heating cycle.
8. Press ✓ to confirm.
9. To program a further heating cycle, if needed, press +.
 - ▶ Program the settings for the further heating cycle. You can program up to 9 heating cycles.
- ✓ The display shows the settings for the programmed heating cycles.
- ✓ The display shows the start time and the end time for the "Sabbath mode" function.
10. Touch the control ring.
 - ✓ The display shows the settings for the programmed heating cycles.
11. Navigate through the list of programmed heating cycles in the menu with the control ring.

10.5 Changing the time period for the "Sabbath mode" function

1. Press Ⓞ.
- ✓ The display shows the settings that have been selected for the "Sabbath mode" function.
2. Press "Summary".
3. Press <.
4. Press →.
- ✓ The display shows the start time and the end time.
5. Press the start time and use the control ring to change the start time.



10.6 Changing settings for the interior lighting

1. Press Ⓞ.
- ✓ The display shows the settings that have been selected for the "Sabbath mode" function.
2. Press "Summary".
3. Press <.
4. To switch the interior lighting on at the lowest lighting level for the entire cooking time while the "Sabbath mode" function is active, set the switch for the interior lighting to "On".
5. To switch the interior lighting off for the entire cooking time while the "Sabbath mode" function is active, set the switch for the interior lighting to "Off".

10.7 Changing the heating cycle

1. Press Ⓞ.
- ✓ The display shows the settings that have been selected for the "Sabbath mode" function.
2. Press "Summary".
3. Press <.
4. Navigate through the list of programmed heating cycles in the menu with the control ring and press the required heating cycle.
5. To change the settings for the heating cycle, press the corresponding settings.
6. To save the changed setting, press <.

10.8 Deleting a heating cycle

1. Press .
- ✓ The display shows the settings that have been selected for the "Sabbath mode" function.
2. Press "Summary".
3. Press .
4. Navigate through the list of programmed heating cycles in the menu with the control ring and select the required heating cycle.
5. Press .

10.9 Starting the "Sabbath mode" function

Tip: Install the manual door opening aid before the Sabbath.

- ▶ Press  to start.
- ✓ The "Sabbath mode" function starts.
- ✓ At the end of the "Sabbath mode" function, the appliance switches off.

10.10 Switching off the "Sabbath mode" function

1. Swipe repeatedly from left to right until the display shows "Modes & Service".
2. Use the control ring to select the "Sabbath mode" function.
3. Set the switch to the right of the "Sabbath mode" list entry to "Off".

Note: To switch off the "Sabbath mode" function, you can also press  on the control ring.

11 Manual door opening aid

11.1 Installing the manual door opening aid

1. Position the manual door opening aid on the side of the appliance where the appliance door opens.
 - ▶ Position the manual door opening aid on the top or bottom corner of the appliance door.
 - ▶ Do not install the manual door opening aid on the surface intended for opening the appliance door.

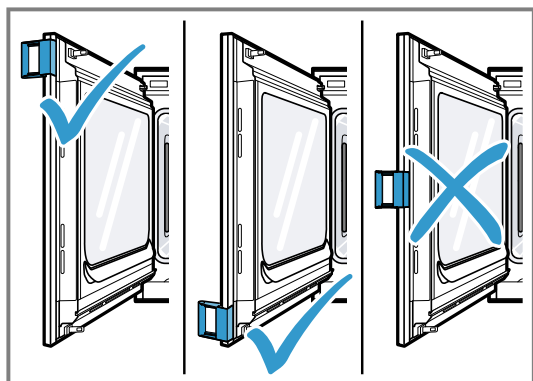

You can also install the manual door opening aid if the appliance door is open.

2. To secure the manual door opening aid to the appliance door, position the manual door opening aid at an angle between the appliance door and the appliance frame and push against the appliance door.

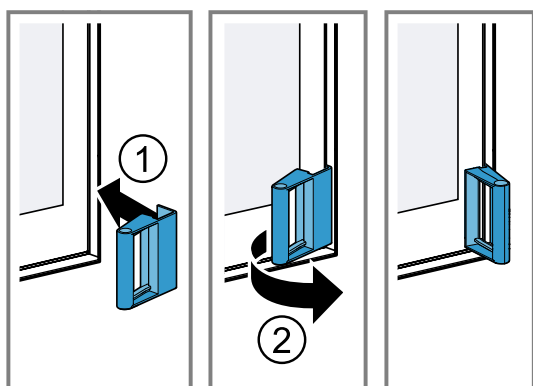

3. Make sure that the manual door opening aid lies flat against the appliance door and that there is no gap

between the side edge of the appliance door and the manual door opening aid.

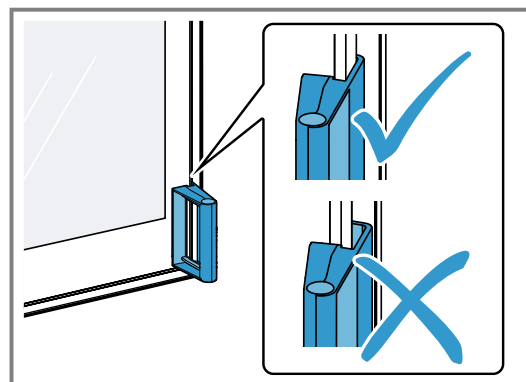

- ✓ You will hear a click.
- ✓ The manual door opening aid is installed.

11.2 Opening the appliance door using the manual door opening aid

- ▶ To open the appliance door using the manual door opening aid, pull the handle on the manual door opening aid.

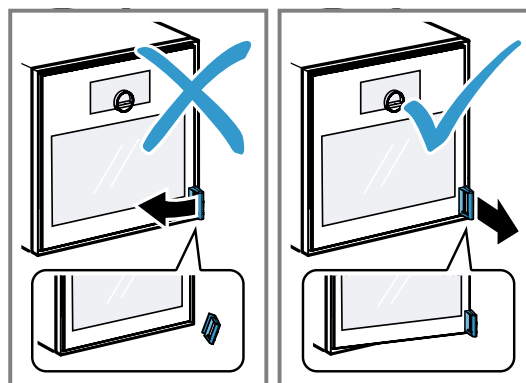

Note: Do not pull the handle to the side as this could cause the manual door opening aid to come loose from the appliance door. Pull the handle straight outwards.

11.3 Cleaning the manual door opening aid

1. Clean the manual door opening aid with hot soapy water and a soft cloth.
2. Dry the manual door opening aid with a soft cloth.

11.4 Removing the manual door opening aid

- ▶ Pull the handle of the manual door opening aid to the side opposite to the direction in which the appliance door opens.

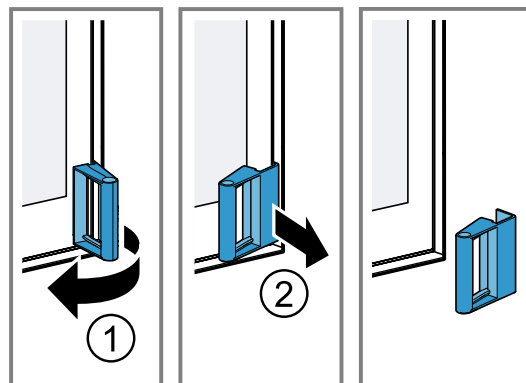

- ✓ The manual door opening aid is removed.

12 Child lock

Activate the "Child lock" function so that children cannot accidentally switch the appliance on or change the settings.



If the child lock is activated, operation via the display and the control ring is not possible.

If the child lock is activated and the power fails, the child lock can be deactivated when the power comes back on.

You can activate the child lock even during operation.

12.1 Activating the childproof lock

Requirement: In the basic settings → *Page 35*, the option "On" is set for the "Display child lock" function.

1. Press .
 2. Press .
- ✓ The display shows .
 - ✓ The "Child lock" function is activated.

12.2 Deactivating the childproof lock

1. Press and hold  for approximately 2 seconds.
- ✓ The "Child lock" function is deactivated.
2. Set the appliance as normal.

13 Favorites

In the "Favorites" appliance display, you can save preferred automatic programs, recommended settings or combinations of type of heating, temperature, core temperature or cooking time. The appliance adopts the selected settings, such as temperature, cooking time, weight or level of browning for the favorites.

You can individually select the names for the favorites. You can use the Home Connect® app to change the saved settings for the favorite or the order of the favorites.



After starting the favorite, you can change the settings. → *"Changing a favorite", Page 28*

13.1 Creating the first favorites

Notes

- You can save a food as a favorite at the beginning or end of an automatic program or a setting recommendation.
- You can save a favorite in the "Manual operation" appliance display. As soon as you have selected the settings for the temperature, the type of heating and the cooking time, the display shows .

Requirement: The settings for the favorites are selected or a heating process ends.

1. Press .
- ✓ The display shows the "Favorites" appliance display.
2. Press .
 3. Use the keyboard to enter a name.
 4. Press .



13.2 Selecting a favorite

1. Swipe repeatedly from right to left until the display shows "Favorites".
2. Use the control ring to select the desired favorite.
3. Press the favorite.

13.3 Renaming a favorite

Requirement: The favorite has been selected.

→ *"Selecting a favorite", Page 27*

1. Press .
2. Enter the name for the favorite.
3. Press  to confirm.

13.4 Starting a favorite

Requirement: The favorite has been selected.

→ "Selecting a favorite", Page 27

- ▶ Press ▶ to start.

13.5 Changing a favorite

The availability of settings depends on the favorite selected.

Requirements

- The favorite has been selected.
→ "Selecting a favorite", Page 27
 - The favorite is stopped.
1. Change the selected settings, e.g. the temperature, the type of heating, or the cooking time.
The "Add broiler" function is unavailable.
The "Condensation function" function is unavailable.
The "Automatic door opening at end of process" function is available.
If you have saved an automatic program as a favorite, you can only change certain settings, e.g. the weight,

the required degree of browning, the thickness of the food or the cooking level of the food.

If you have saved a recommended setting as a favorite, you can change the settings on the appliance as soon as the favorite is started. You can only save the changed settings via the Home Connect® app. As soon as the favorite is stopped or has finished, the Home Connect® app asks if you would like to save the settings in the favorite.

2. Press ✓.

3. Press ▶ to start.

- ✓ The operation starts with the changed settings.

Note: The appliance does not save the changed settings in the selected favorite. If you select the favorite again, the settings match the settings when the favorite was created.

You can use the Home Connect® app to change the settings for the favorites.

13.6 Deleting a favorite

Requirement: The favorite has been selected.

→ "Selecting a favorite", Page 27

1. Press ☒.

2. Press ✓ to confirm.

14 Programs

The "Programs" appliance display includes the automatic programs and recommended settings.

14.1 Automatic programs

You can use the "Automatic programs" function to cook a wide variety of food. The appliance will choose the optimal setting for you.

In automatic programs, the appliance defines the optimal settings after you enter the weight and required cooking result, for example. The automatic programs are labeled with a checkmark in the overview list. Depending on the type of heating, the cooking time only begins once the appliance has preheated. You can find information about the accessories or shelf levels in the tip for the respective program.

Note: In the basic settings → Page 35, you can filter automatic programs, e.g. with the following filters "Vegetarian" or "No meat & poultry".

Information about the settings for the automatic programs

Observe the instructions for the settings of the automatic programs.

- The cooking result depends on the quality of the food and the size and type of cookware. For an optimal cooking result, only use food that is in good condition and meat that is chilled to refrigerator temperature. For frozen food, use food straight out of the freezer only.
- The food is divided into categories. One or more dishes are listed for each category. The display shows the last selected meal.
- For some dishes, the appliance asks you to enter, for example, the weight, the desired level of browning,

the thickness of the food or the cooking level of the food.

- For some food, preheat the empty cooking compartment for an optimal cooking result. Place the food in the cooking compartment once the preheating is complete and a message appears in the display.
- The appliance displays the selected settings next time as a suggestion.
- For some programs, you need the core temperature probe. Use the core temperature probe → Page 30 for these programs.
- To achieve good results, the cooking compartment must not be too hot for the type of food you have selected. If the cooking compartment is too hot, the display shows a corresponding notification. Allow the appliance to cool and then try again.

Selecting an automatic program

1. Swipe repeatedly from right to left until the display shows "Programs".
 - ✓ The display shows the first program in the "Vegetables" category or the last set automatic program.
 - ✓ The display shows the preselected values for the program or the last set values.
 - ✓ The display shows a tip and symbols for the Favorites → Page 27 category and for the program start.
2. Use the control ring to select the required meal, and press on the required meal.
 - ✓ The display shows the name of the selected dish and the corresponding values.

Changing category

1. Press the symbol for the category.
 - ✓ The display shows the available categories in the ring menu.

2. Select the required category with the control ring.
 3. Press < or press the category in order to confirm the selection.
- ✓ The display shows the first dish in the selected category and the corresponding values.

Changing the program

1. Press on the name of a dish or navigate through the list of dishes in the menu with the control ring.
 2. Press the required dish.
- ✓ The display shows the name of the selected dish and the corresponding settings.
3. Press the setting.
 4. Use the control ring to change the setting and press on the required setting.
Not all settings can be changed.
You cannot change the type of heating.
 5. Press <.
- ✓ The display shows the name of the selected dish and the corresponding settings.
6. Press □.
- ✓ The display shows information about the accessories and preparation.
7. Follow the information on the display.

Starting the automatic program

- ▶ Press ▶.
- ✓ Once the cooking time has elapsed, a signal tone sounds.
- ✓ The appliance stops heating.
- ✓ The appliance carries out steam removal.

Note: If you open the appliance door during an automatic program, this affects the cooking result. Do not open the appliance door, or only open it briefly. The appliance interrupts the automatic program and continues to run when you close the appliance door.

Extending the cooking time

If you are still not satisfied with the cooking result, you can increase the cooking time again.

1. Press 00.00.
2. Select the required cooking time.
3. Press ✓ to confirm.

Note: If you press ⚡, during the cooking process, the appliance carries out steam removal and the cooking process is ended.

Canceling the automatic program

Note: Once you have started the automatic program, you can no longer change the settings.

- ▶ Press ■.
- ✓ The appliance ends the automatic program.

Saving a program as a favorite

You can save a program as a favorite at the start or end of an automatic program.

1. Press □.
- ✓ The display shows the "Favorites" appliance display.
2. Press ⏎.
3. Use the keyboard to enter a name.
4. Press ✓.
You can only change the settings for a saved favorite via the Home Connect® app.

14.2 Recommended settings

With recommended settings, the appliance specifies the optimal type of heating.

The recommended settings are not labeled with a checkmark in the overview list.

If a weight is specified in the tip, the recommended temperature and the cooking time relate to this weight specification. You can adapt the temperature and cooking time within the available ranges.

Depending on the type of heating, the cooking time only begins once the appliance has preheated. You can find information about the accessories or shelf levels in the tip for the respective program.

Information on the recommended settings

Observe the information on the recommended settings.

- The cooking result depends on the quality of the food and the size and type of cookware. For an optimal cooking result, only use food that is in good condition and meat that is chilled to refrigerator temperature. For frozen food, use food straight out of the freezer only.
- The food is divided into categories. One or more dishes are listed for each category. The display shows the last selected meal.
- With the recommended settings, the appliance specifies the type of heating.
- You can change the temperature and the cooking time in the specified areas.
- For some food, preheat the empty cooking compartment for an optimal cooking result. Place the food in the cooking compartment once the preheating is complete and a message appears in the display.
- The appliance displays the selected settings next time as a suggestion.
- To achieve good results, the cooking compartment must not be too hot for the type of food you have selected. If the cooking compartment is too hot, the display shows a corresponding notification. Allow the appliance to cool and then try again.

Selecting a recommended setting

1. Swipe repeatedly from right to left until the display shows "Programs".
 - ✓ The display shows the first program in the "Vegetables" category or the last set automatic program.
 - ✓ The display shows the preselected values for the program or the last set values.
 - ✓ The display shows a tip and symbols for the Favorites → *Page 27* category and for the program start.
2. Use the control ring to select the required meal, and press on the required meal.
- ✓ The display shows the name of the selected dish and the corresponding values.

Changing category

1. Press the symbol for the category.
- ✓ The display shows the available categories in the ring menu.
2. Select the required category with the control ring.
3. Press < or press the category in order to confirm the selection.
- ✓ The display shows the first dish in the selected category and the corresponding values.

Changing the program

1. Press on the name of a dish or navigate through the list of dishes in the menu with the control ring.
2. Press the required dish.
- ✓ The display shows the name of the selected dish and the corresponding settings.
3. Press the setting.
4. Use the control ring to change the setting and press on the required setting.
Not all settings can be changed.
You cannot change the type of heating.
5. Press <.
- ✓ The display shows the name of the selected dish and the corresponding settings.
6. Press □.
- ✓ The display shows information about the accessories and preparation.
7. Follow the information on the display.

Starting a recommended setting

- ▶ Press ▶.
- ✓ Once the cooking time has elapsed, a signal tone sounds.
- ✓ The appliance stops heating.
- ✓ The appliance carries out steam removal.

Note: If you open the appliance door when a recommended setting is running, this affects the cooking result. Do not open the appliance door, or only open it briefly. The appliance interrupts the recommended setting and continues to run when you close the appliance door.

Extending the cooking time

If you are still not satisfied with the cooking result, you can increase the cooking time again.

1. Press 00.00.
2. Select the required cooking time.
3. Press ✓ to confirm.

Note: If you press ⚙, during the cooking process, the appliance carries out steam removal and the cooking process is ended.

Changing a recommended setting

Note: Once you have started the recommended setting, you can change the settings.

1. Press on the recommended setting.
2. Change the desired settings.

Saving a program as a favorite

You can save a program as a favorite at the start or end of a recommended setting.

Requirements

- The temperature and type of heating are set.
 - The cooking time or core temperature is set.
1. Press □.
 - ✓ The display shows the "Favorites" appliance display.
 2. Press ./.
 3. Use the keyboard to enter a name.
 4. Press ✓.
You can only change the settings for a saved "Favorites" via the Home Connect® app.

15 Core temperature sensor

The core temperature probe makes it possible to cook with exact precision. The core temperature probe measures the temperature at 3 measuring points inside the food. When the required core temperature is reached, the appliance automatically switches off, ensuring that all food is cooked perfectly.

WARNING

The oven cavity and the core temperature probe become very hot.

- ▶ Use oven gloves when inserting and removing the core temperature probe.

NOTICE

Temperatures above 480°F (250°C) damage the core temperature probe.

- ▶ Only use the core temperature probe in your appliance at a maximum temperature of 445°F (230°C).
- ▶ Do not use the core temperature probe with the "Broil" type of heating.
- ▶ Before using the "Broil" type of heating, remove the core temperature probe from the cooking compartment.
- ▶ When using the core temperature probe with the "Broil + circulated air" type of heating, set the temperature to a maximum of 480°F (250°C).

WARNING

An incorrect core temperature probe may damage the insulation.

- ▶ Only use the core temperature probe that is suitable for this appliance.

NOTICE

Aggressive cleaning agents may damage the core temperature probe.

- ▶ Do not clean the core temperature probe in the dishwasher.

WARNING

The core temperature probe is sharp.

- ▶ Handle the core temperature probe with care.

Only use the core temperature probe that is suitable for this appliance. The core temperature probe → *Page 18* is available as a spare part from customer service or the online shop. You can also use the core temperature probe of the Gaggenau oven or the microwave oven of the same appliance series.

If you use the core temperature probe, never place the food on the top shelf level.

After use, always remove the core temperature probe from the cooking compartment. Never store the core temperature probe in the cooking compartment.

After each use, clean the core temperature probe with a damp cloth.

The measurable range is 60-212 °F (15 °C to 100 °C). Outside of the measurable range, the display shows "<60 F (15 °C)" or ">212 F (100 °C)" for the current core temperature.

If you leave food in the cooking compartment for some time after cooking, the core temperature will continue to rise somewhat due to the residual heat in the cooking compartment.

15.1 Inserting the core temperature probe into the food

1. Insert the core temperature probe fully into the food.
2. Do not insert the core temperature probe into the fat.
3. Ensure that the core temperature probe is not touching any cookware or any bones.
4. Place the food in the oven cavity.

Inserting the core temperature probe into meat

1. Insert the core temperature probe at the thickest point on the side as far as it will go into the meat.

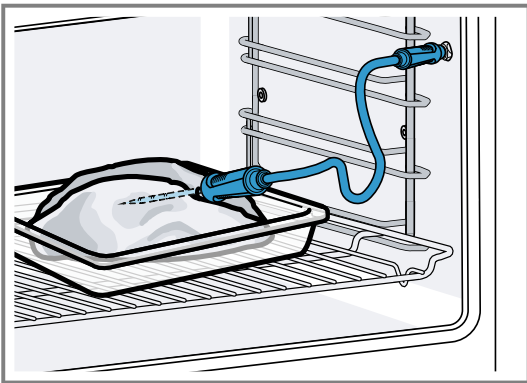

2. If there is more than one piece of meat, insert the core temperature probe into the middle of the thickest piece.

Inserting the core temperature probe into poultry

1. Insert the core temperature probe as far as it will go into the thickest point in the breast.

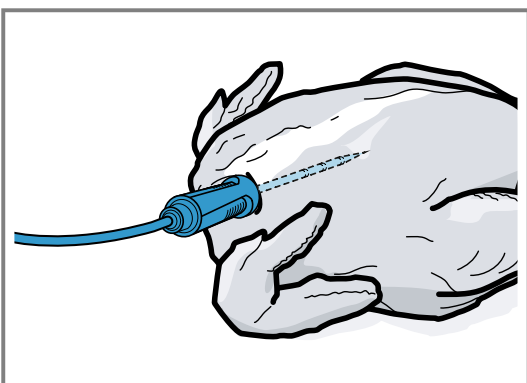

2. Depending on its composition, insert the core temperature probe into the poultry crossways or lengthways.

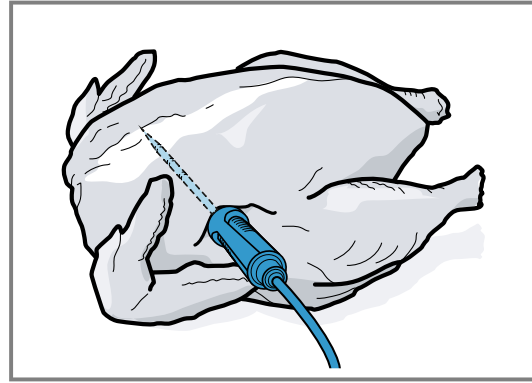

3. With poultry, ensure that the tip of the core temperature probe does not protrude into the cavity in the middle of the bird.

Inserting the core temperature probe into fish

1. Insert the core temperature probe behind the head as far as it will go towards the spine.

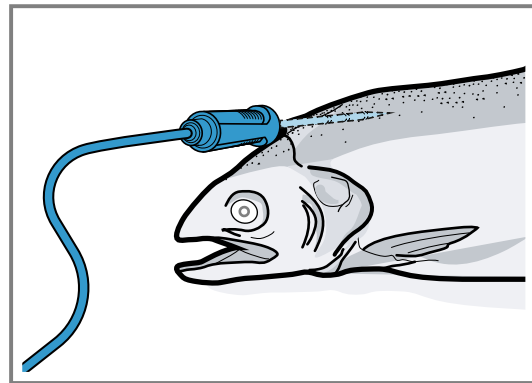

2. Place the whole fish onto the wire rack and prop it up in the swimming position using half a potato.

15.2 Turning the food

1. Do not pull out the core temperature probe when turning the food.
2. Turn the food.
3. Once you have turned the food, check that the core temperature probe is correctly positioned in the food.

15.3 Setting the core temperature probe

NOTICE



The heat of the grilling surface may damage the core temperature probe.

- ▶ Ensure that the distance between the glass grilling surface and the core temperature probe and the cable of the core temperature probe is a few centimeters. In doing so, ensure that the meat can expand during the cooking process.

You may damage the cable of the core temperature probe with the appliance door.

- ▶ Do not trap the cable of the core temperature probe in the appliance door.

Requirement: A cooking time end is not set. The cooking time end and core temperature probe functions are not available at the same time.

1. Slide the food into the oven cavity with the core temperature probe inserted.
2. Insert the core temperature probe into the socket in the oven cavity.
3. Close the appliance door.
- ✓ The display shows the current interior oven temperature and the symbol for the core temperature probe .
4. Select the required type of heating and interior oven temperature using the control ring.
5. Press .
6. Use the control ring to select the required core temperature → *Page 32*.
 - ▶ Ensure that the set core temperature is higher than the current core temperature.

You can change the set core temperature at any time.
7. The set core temperature can be cleared and reset as needed using C or the control ring.
8. Press < or press the set core temperature.
9. Press ▶.
- ✓ The appliance heats up using the set type of heating.
- ✓ Once you have set the core temperature, the display shows the type of heating and the current core temperature.
- ✓ Once you have set the core temperature, the display shows the type of heating and switches between displaying the estimated time → *Page 33* until the core temperature is reached and the current and set core temperature.
- ✓ If the current core temperature is 9°F (5°C) below the set core temperature, the display shows the current and set core temperature as enlarged.
- ✓ Once the core temperature for the food has been reached, the display shows the required core temperature alongside the set core temperature and a signal sounds.
- ✓ The appliance ends the cooking process automatically.

Note: If you do not continue to operate the appliance after the signal tone, the display shows how much time has elapsed since the food reached the core temperature.

Once you start operating the appliance again, the appliance clears the time display. After around 20 minutes without any further operation, the appliance switches to low power mode.

15.4 Deleting the set core temperature

- ▶ In the "Manual" appliance display, double-click on the temperature.
- ✓ The display shows the current core temperature.

15.5 Changing the set core temperature

1. Press .
2. Change the set core temperature using the control ring.

Once the display shows the set core temperature enlarged in the 12 o'clock position, you can change the set core temperature directly using the control ring.

15.6 Using the core temperature probe with the "Sous-vide cooking" type of heating

Note: Only use foam tape and cooking bags that are heat-resistant, suitable for sous-vide cooking, and of high quality.

1. Position the food in a special heat-resistant sous-vide cooking bag.
2. Vacuum-seal the food in the cooking bag.
3. Stick the heat-resistant foam tape onto the cooking bag.
4. Insert the core temperature probe through the foam tape, the cooking bag and the thickest part of the food.
 - ▶ Position the tip of the core temperature probe in the center of the food.

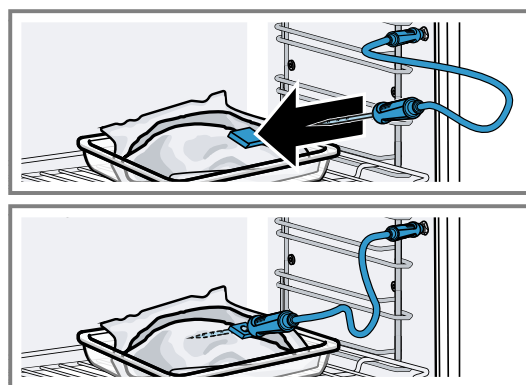

5. Set the interior temperature at least 2-4°F (1-2°C) higher than the desired core temperature.

15.7 Core temperature guideline values

The following overview provides you with guideline values for the core temperature. The guideline values depend on the quality and composition of the food. Only use fresh food that has not been frozen. For hygiene reasons, ensure that critical foods such as fish and game reach a core temperature of at least 140-160 °F (62-70 °C) and poultry and minced meat 180-195 °F (80-90 °C).

Food	Core temperature guideline value in °F (°C)
Beef	
Sirloin, fillet of beef, entrecôte, roast beef, rare	116-131 (47-55)
Sirloin, fillet of beef, entrecôte, roast beef, medium rare	133-145 (56-63)
Sirloin, fillet of beef, entrecôte, roast beef, medium	147-158 (64-70)
Sirloin, fillet of beef, entrecôte, roast beef, well done	160-167 (71-75)
Pork	
Joint of pork	167-176 (75-80)
Loin of pork, medium rare	149-158 (65-70)
Loin of pork, medium	160-167 (71-75)
Pork loin, well done	169-176 (76-80)

Food	Core temperature guideline value in °F (°C)
Meatloaf	185 (85)
Fillet of pork, medium rare	149-158 (65-70)
Fillet of pork, medium	160-167 (71-75)
Veal	
Joint of veal, well done	167-176 (75-80)
Breast of veal, stuffed, well done	167-176 (75-80)
Saddle of veal, medium	147-158 (64-70)
Saddle of veal, well done	160-167 (71-75)
Fillet of veal, rare	120-131 (50-55)
Fillet of veal, medium rare	133-145 (56-63)
Fillet of veal, medium	147-158 (64-70)
Fillet of veal, well done	160-167 (71-75)
Game	
Saddle of venison	140-158 (60-70)
Leg of venison	158-167 (70-75)
Venison loin steaks	149-158 (65-70)
Saddle of hare, saddle of rabbit	149-158 (65-70)
Poultry	
Chicken	194 (90)
Guinea fowl	176-185 (80-85)
Goose, turkey, duck	185-194 (85-90)
Duck breast, medium rare	131-140 (55-60)
Duck breast, medium	141-158 (61-70)
Duck breast, well done	160-176 (71-80)
Ostrich steak	140-149 (60-65)
Lamb	
Leg of lamb, medium	149-156 (65-69)
Leg of lamb, well done	158-176 (70-80)
Saddle of lamb, medium rare	131-140 (55-60)
Saddle of lamb, medium	141-147 (61-64)

Food	Core temperature guideline value in °F (°C)
Saddle of lamb, well done	149-167 (65-75)
Mutton	
Leg of mutton, medium rare	158-176 (70-75)
Leg of mutton, medium	169-176 (76-80)
Leg of mutton, well done	178-185 (81-85)
Saddle of mutton, medium	158-176 (70-75)
Saddle of mutton, well done	169-176 (76-80)
Fish	
Fillet, whole, medium	136-147 (58-64)
Fillet, whole, well done	149-154 (65-68)
Terrine	144-149 (62-65)
Other	
Bread	205 (96)
Pâté	162-167 (72-75)
Terrine	158-176 (70-75)
Foie gras	113-140 (45-60)
Reheating food	167 (75)

15.8 Estimated cooking time

After preheating, if the appliance has a temperature setting above 250 °F (120 °C) and the core temperature probe is inserted, the display shows an estimated cooking time a few minutes into the cooking time. The appliance continuously updates the estimated cooking time. The estimated cooking time is only available if you connect your appliance to the Home Connect® app. The longer the cooking process lasts, the more precise the estimated cooking time becomes. Do not open the appliance door; this distorts the estimated cooking time. The display shows the estimated cooking time in manual operation and in the automatic program. To display the current core temperature, press on the set core temperature.

16 Home Connect®

This appliance is network-capable. Connecting your appliance to a mobile device lets you control its functions via the Home Connect® app, adjust its basic settings and monitor its operating status.

The Home Connect® services are not available in every country. The availability of the Home Connect® function depends on the availability of the Home Connect® services in your country. You can find information on this at: www.home-connect.com.

The Home Connect® app guides you through the entire registration process. Follow the instructions, noting the information in the Home Connect® app.

Notes

- Note the safety information in this instruction manual and ensure that it is also observed when operating the appliance using the Home Connect® app.

- Operating the appliance on the appliance itself always takes priority. It is not possible to operate the appliance using the Home Connect® app during this time.
- In networked standby mode, the appliance requires a maximum of 2 watts.

16.1 Setting up Home Connect®

Requirements

- The appliance is connected to the power supply and is switched on.
- You have a mobile device with a current version of the iOS or Android operating system, e.g. a smartphone.
- The appliance receives signals from the WLAN home network (Wi-Fi) at its installation location.

- The mobile device and the appliance are within range of your home network's Wi-Fi signal.

1. Scan the following QR code.



You can install the Home Connect® app and connect your appliance via the QR code.

2. Follow the instructions in the Home Connect® app.

16.2 Home Connect® settings

You can adjust the home network settings in your appliance's basic settings.

Which settings the display shows will depend on whether Home Connect® has been set up and whether the appliance is connected to your home network.

You can switch the network connection on or off as required. The network information is retained after the appliance is switched off. After switching on the appliance, wait for a few seconds until it reconnects to the home network.

The display uses different symbols to show the connection strength to the router.

Note: In networked standby mode, the appliance requires a maximum of 2 W.

You can use the Home Connect® app to access the appliance's functions. If you select the "Off (monitoring only)" setting in the basic settings → *Page 35* for "Remote start", the Home Connect® app only shows the appliance's operating status and you can configure the settings.

If you select the "Permanent" setting in the basic settings → *Page 35* for "Remote start", you can start and operate your appliance at any time without any prior approval on the appliance.

If you select the "Manual" setting in the basic settings → *Page 35* for "Remote start", the appliance requires approval in the control center in order to start a function. In the basic settings → *Page 35*, you can use "Network information" to display the network information. In the basic settings → *Page 35*, you can use "Network credentials reset" to delete all network access data from the appliance at any time.

16.3 Starting functions with the Home Connect® app via manual "Remote start"

You can use the Home Connect® app to set the appliance remotely via the "Remote start" function. If you select the "Manual" setting in the basic settings for "Remote start", the appliance requires approval in the control center in order to start a function.

⚠ WARNING

Combustible objects that are left in the cooking compartment may catch fire.

- ▶ Never store combustible objects in the cooking compartment.
- ▶ If smoke is emitted, the appliance must be switched off or the fuse must be switched off and the door must be held closed in order to stifle any flames.

Requirements

- The appliance is connected to the home network and to the Home Connect® app.
- To start a function, the "Manual" setting is selected in the basic settings for "Remote start".

1. To activate manual remote start, press and then .

2. Configure a setting in the Home Connect® app and send it to the appliance.

3. Start a function.

Note: If you open the appliance door more than 15 minutes after activating remote start or after the operation ends, the appliance deactivates the manual remote start.

24 hours after activating remote start, the appliance deactivates the manual remote start.

16.4 Starting functions with the Home Connect® app via permanently activated "Remote start"

You can use the Home Connect® app to set and start the appliance remotely via the "Remote start" function. If you select the "Permanent" setting in the basic settings for "Remote start", the appliance does not require approval in the control center in order to start a function.

⚠ WARNING

Combustible objects that are left in the cooking compartment may catch fire.

- ▶ Never store combustible objects in the cooking compartment.
- ▶ If smoke is emitted, the appliance must be switched off or the fuse must be switched off and the door must be held closed in order to stifle any flames.

Requirements

- The appliance is connected to the home network and to the Home Connect® app.
- To start a function, the "Permanent" setting is selected in the basic settings for "Remote start".

1. Configure a setting in the Home Connect® app and send it to the appliance.

2. Start a function.

16.5 Using the Home Connect® app to change settings

You can use the Home Connect® app to set the appliance remotely.

⚠ WARNING

Combustible objects that are left in the cooking compartment may catch fire.



- ▶ Never store combustible objects in the cooking compartment.
- ▶ If smoke is emitted, the appliance must be switched off or the fuse must be switched off and the door must be held closed in order to stifle any flames.

Requirement: The appliance is connected to the home network and to the Home Connect® app.

- ▶ Configure a setting in the Home Connect® app and send it to the appliance.

16.6 Switching the Wi-Fi on or off

Requirement: The "On" and "Off" settings are only available if a connection to the Home Connect® server has been established.

1. Press  in the status line.
2. Press  in the control center.
3. Press the desired setting.
4. If required, use < to switch to "Settings".

16.7 Software update

Your appliance's software can be updated using the software update function, e.g. for the purposes of optimization, troubleshooting or security updates.

To do this, you must be a registered Home Connect® user, have installed the app on your mobile device and be connected to the Home Connect® server. As soon as a software update is available, you will be informed via the Home Connect® app and will be able to start the software update via the app. Once the update has been successfully downloaded, you can start installing it via the Home Connect® app if you are in your home network (Wi-Fi). The Home Connect® app informs you once the installation is successful.

You can find the current software version in the Home Connect® app under the appliance information for the appliance.

Notes

- The software update consists of two steps.

- The first step is the download.
- The second step is the installation on your appliance.
- You can continue to use your appliance as normal while updates are downloading. Depending on your personal settings in the app, software updates can also be set to download automatically.
- Installation takes a few minutes. You cannot use your appliance during installation.
- We recommend that you install security updates as soon as possible.

16.8 Data Protection

Please read this information on data protection.

The first time your appliance is registered on a home network connected to the Internet, your appliance transmits the following types of data to the Home Connect® server (initial registration):

- Unique appliance identification (consisting of appliance codes as well as the MAC address of the installed Wi-Fi communication module).
- Security certificate of the Wi-Fi communication module (to ensure a secure data connection).
- The current software and hardware version of your home appliance.
- Status of any previous reset to factory settings.

This initial registration prepares the Home Connect® functions for use and is only required when you want to use the Home Connect® functions for the first time.

Note: Please note that the Home Connect® functions can only be used in conjunction with the Home Connect® app. Information on data protection can be retrieved in the Home Connect® app.

17 Basic settings

You can configure the basic settings for your appliance to meet your needs.

17.1 Overview of the basic settings

Here you can find an overview of the basic settings and factory settings. The basic settings depend on the features of your appliance.

Symbol	Basic setting	Setting	Selection	Use
	Wi-Fi	Wi-Fi	<ul style="list-style-type: none"> ▪ On ▪ Off¹ 	Switching the Wi-Fi on or off

¹ Factory setting (may vary according to model)

Symbol	Basic setting	Setting	Selection	Use
				<p>Note: The On and Off settings are only available if a connection to the Home Connect® server has been established.</p> <p>All settings are retained after the appliance is switched off.</p> <p>Switch on the Wi-Fi in order to allow the appliance to be controlled via the app and to use additional appliance functions.</p>
		Home Connect® assistant	<ul style="list-style-type: none"> ▪ During the initial connection to the Home Connect® app: "Start" ▪ If you have already connected successfully to the Home Connect® app: "Connect now" 	Setting up Home Connect® → <i>Page 33</i>
		Remote start	<ul style="list-style-type: none"> ▪ Off (monitoring only) ▪ Manual ¹ ▪ Permanent <p>Note: The settings are only available if you have selected the "On" setting for Wi-Fi.</p>	Setting "Remote start" → <i>"Starting functions with the Home Connect® app via manual 'Remote start'", Page 34</i>
		Network information	<ul style="list-style-type: none"> ▪ MAC address ▪ Wi-Fi SSID ▪ IPv4 address ▪ IPv6 address <p>Note: The settings are only available if you have selected the "On" setting for Wi-Fi.</p>	Displaying "Network information"
		Network credentials reset	<ul style="list-style-type: none"> ▪ Confirm <p>The connections are reset. The appliance deletes saved network access data.</p> <p>Note: The settings are only available if you have selected the "On" setting for Wi-Fi.</p>	Reset the network access data
	Display	Brightness	<ul style="list-style-type: none"> ▪ 1 ▪ 2 ▪ 3 ▪ 4 ¹ ▪ 5 ▪ 6 	Sets the brightness in increments





¹ Factory setting (may vary according to model)

Symbol	Basic setting	Setting	Selection	Use
		Distant view	<ul style="list-style-type: none"> ▪ "On"¹: The display shows less content if you are at a greater distance. ▪ "Off": The display always shows the same content. 	Switch the remote view on or off
		Screen in off-mode	<ul style="list-style-type: none"> ▪ GAGGENAU logo"displayed on approach"¹ ▪ None 	Sets the low power mode display → <i>Page 16</i>
		Ring behavior	<ul style="list-style-type: none"> ▪ "Standard": Press the required function and use the control ring to change the function ▪ "Quick selection"¹: Use the control ring to change the function located above the control ring 	Set the control ring behavior
		Display child lock	<ul style="list-style-type: none"> ▪ "On"¹: The symbol for the "Display child lock" function is only visible in the status line if the "Display child lock" function is active. Control ring and touch fields are locked. ▪ "Off": The "Display child lock" function cannot be activated. 	Displays or hides the symbol for the child lock → <i>Page 27</i> in the control center
		Door lock	<ul style="list-style-type: none"> ▪ Activated ▪ Off¹ 	Activates or deactivates the door lock Note: The door lock → <i>Page 17</i> prevents the appliance door from being opened accidentally. This is particularly useful when installing the appliance under the countertop.
		Display alignment	<ul style="list-style-type: none"> ▪ Vertical¹ ▪ Horizontal 	Aligns the display horizontally or vertically depending on the appliance's installation position or the user's body size
	Sounds	Switch-on/switch-off sounds	<ul style="list-style-type: none"> ▪ Quiet ▪ Standard¹ ▪ Loud 	Set the volume of the on/off tones
		Notification sounds	<ul style="list-style-type: none"> ▪ Off ▪ Quiet ▪ Standard¹ ▪ Loud 	Set the volume of the notification tones

¹ Factory setting (may vary according to model)

Symbol	Basic setting	Setting	Selection	Use
				Note: The notification tones for the warnings and error messages always remain switched on.
		Process sounds	Volume <ul style="list-style-type: none"> ▪ Off ▪ Quiet ▪ Standard ¹ ▪ Loud "Repetitions": <ul style="list-style-type: none"> ▪ 1x ▪ "10 s": The appliance emits the signal tone repeatedly for 10 seconds. ▪ "30 s" ¹: The appliance emits the signal tone repeatedly for 30 seconds. ▪ "3 min": The appliance emits the signal tone repeatedly for 3 minutes. "Preheating signal": <ul style="list-style-type: none"> ▪ "On" ¹ ▪ Off 	<ul style="list-style-type: none"> ▪ Set the volume of the process tones ▪ Sets the desired maximum duration of the process tones ▪ Activates or deactivates the process tone following pre-heating
		Visual feedback	<ul style="list-style-type: none"> ▪ On ▪ Off ¹ 	Switches the pulsating light for program end, notifications or error messages on or off
		Volume reduction	<ul style="list-style-type: none"> ▪ "On": Lowers the volume for all tones to a certain volume level in a defined period ▪ "Reduced": Lowers the volume for all tones to the "Quiet" volume level in a defined period and switches off the tones for cleaning ▪ "Off" ¹: Switches off all tones in a defined period Start time <ul style="list-style-type: none"> ▪ "22h" ¹ End time <ul style="list-style-type: none"> ▪ "7h" ¹ 	Sets the lowering of the volume Note: The signal tones for warnings, error messages, and switching on and switching off always remain switched on.
	Interior lighting	Brightness	<ul style="list-style-type: none"> ▪ Dark ▪ Standard ¹ ▪ Bright 	Sets the brightness of the interior lighting
		Activation	<ul style="list-style-type: none"> ▪ Automatic ¹ ▪ Manual 	Switches the interior lighting on automatically or manually
		Light interaction	<ul style="list-style-type: none"> ▪ On ¹ ▪ Off 	Sets the light interaction

¹ Factory setting (may vary according to model)

Symbol	Basic setting	Setting	Selection	Use
				Note: If you are outside of the range that the appliance recognizes, the appliance reduces the interior lighting to what is essential.
	Notifications	Info-i	<ul style="list-style-type: none"> ▪ On ¹ ▪ Off 	Display or hide additional information Tip: If you press  , the display shows additional information → <i>Page 16</i> . If you switch off the function, the display does not show any symbol or any additional information.
		Pop-up hints	<ul style="list-style-type: none"> ▪ On ¹ ▪ Off 	Displays or hides pop-up notifications → <i>Page 16</i>
	Language	-	<ul style="list-style-type: none"> ▪ German ▪ French ▪ [...] ▪ English ¹ 	Setting the language
	Time and units	Time	<ul style="list-style-type: none"> ▪ Time ¹ ▪ "Automatic": Select the "Automatic" option if your appliance is connected to Home Connect®. 	Set the time
		Time format	<ul style="list-style-type: none"> ▪ 12 ▪ 24 ¹ 	Set the time format
		Temperature unit	<ul style="list-style-type: none"> ▪ °C ¹ ▪ °F 	Set the temperature unit
		Weight unit	<ul style="list-style-type: none"> ▪ "Metric": "g/kg" ▪ "Imperial": "oz/lb" 	Set the weight unit
		Volume unit	<ul style="list-style-type: none"> ▪ "Metric": "ml/l" ▪ "Imperial": "fl oz" ¹ 	Set the capacity unit
	Advanced	Display Sabbath mode	<ul style="list-style-type: none"> ▪ On ▪ Off ¹ 	Displays or hides the "Sabbath mode" function
		Demo mode	<ul style="list-style-type: none"> ▪ On ▪ Off ¹ 	Activates or deactivates demo mode Note: The setting is only available in the first 3 minutes after connecting to the power supply.
		Factory settings	<ul style="list-style-type: none"> ▪ Restore 	Resets the appliance to the factory settings

¹ Factory setting (may vary according to model)

Symbol	Basic setting	Setting	Selection	Use
				Note: The appliance starts the initialization. The display asks you to specify settings that the appliance installer has implemented.
	Appliance	Start screen	<ul style="list-style-type: none"> ▪ Manual ¹ ▪ Favorites ▪ Programs 	Select a display that shows the display after switching on
		Preselection of types of heating	<p>Overview of the available types of heating → <i>Page 14.</i></p> <ul style="list-style-type: none"> ▪ On ▪ Off 	<p>Selects the preferred types of heating</p> <ul style="list-style-type: none"> ▪ Selects the preferred type of heating that is available after the appliance is switched on ▪ If required, displays or hides additional types of heating at a later point <p>Note: The sequence of the types of heating is defined.</p>
		Food preference	<ul style="list-style-type: none"> ▪ Off ¹ ▪ Vegetarian ▪ No meat & poultry ▪ No fish & seafood ▪ No pork ▪ Kosher 	Selects the preferred food for automatic programs and recommended settings
		Count-up cooking timer	<ul style="list-style-type: none"> ▪ On ¹ ▪ Off 	<p>Sets the total cooking time timer</p> <p>Note: The running cooking time is automatically counted up if no cooking time has been stored.</p>
		User detection	<p>"Behavior":</p> <ul style="list-style-type: none"> ▪ Automatic ▪ "Below 3' 11" (1.2 m)"- "Below 4" (0.1 m)" <p>"Installation height":</p> <ul style="list-style-type: none"> ▪ Under 91.4 cm/36" ▪ Between 91.4 cm/36" and 150 cm/59" ¹ ▪ Over 150 cm/59" 	<ul style="list-style-type: none"> ▪ Sets the distance from which the proximity sensor detects the user ▪ Set the appliance's installation height <p>Note: To ensure that the proximity sensor optimally detects the user, store the installation height of the appliance's upper edge.</p>
		Introduction to the appliance	Start	<p>Start the appliance introduction</p> <p>Note: The appliance introduction contains a short description of the basic functions.</p>

¹ Factory setting (may vary according to model)

17.2 Changing the basic settings

1. Swipe repeatedly from left to right until the display shows Basic settings → *Page 35*.
- ✓ The display shows the symbols for the available settings in a ring menu.
2. Use the control ring to select the required basic setting.
3. Press the required basic setting.
- ✓ The display shows the settings for the selected basic setting.

4. Depending on the selected basic setting, use the control ring to select the setting, or press the required setting.
 - ▶ With a list menu, ensure that the required setting is above the horizontal line.
5. Use \rightarrow to activate the setting or use the control ring to select the setting option, and press the setting.
6. If required, use < to switch to the previous view.

18 Cleaning and maintenance

Note: The Statement of Limited Product Warranty covers defects in materials and workmanship. Cleaning and maintenance is not covered by the warranty and a charge will apply. See the Statement of Limited Product Warranty for more details.

18.1 Cleaning agents

To avoid damaging the various surfaces on the appliance, do not use any unsuitable cleaning agents.

WARNING

Moisture intrusion may cause an electric shock.

- ▶ Do not use any steam cleaners or high-pressure cleaners to clean the appliance.

WARNING

The appliance and its parts that can be touched become hot during use.

- ▶ Caution should be exercised here in order to avoid touching heating elements.
- ▶ Young children under 8 years of age must be kept away from the appliance.

WARNING

Scratched glass in the appliance door may develop into a crack.

- ▶ Do not use any harsh or abrasive cleaners or sharp metal scrapers to clean the glass on the appliance door, as they may scratch the surface.

Suitable cleaning agents

Only use cleaning agents that are suitable for the different surfaces on your appliance.

Appliance door

Area	Suitable cleaning agents	Information
Door pane	<ul style="list-style-type: none"> ▪ Glass cleaner 	Do not use a glass scraper. Clean it using a soft cloth or a microfiber cloth.
Door seal	<ul style="list-style-type: none"> ▪ Hot soapy water 	Clean with a dish cloth. Do not remove or scrub. Do not use metal scrapers or glass scrapers for cleaning.
Control ring	<ul style="list-style-type: none"> ▪ Soapy water 	Clean with a slightly damp soft cloth. Do not spray with any cleaning agent.

Cooking compartment

Area	Suitable cleaning agents	Information
Oven cavity inner walls	<ul style="list-style-type: none"> ▪ Hot soapy water 	Clean with a dishcloth and dry with a soft cloth.

NOTICE

Unsuitable cleaning agents damage the surfaces of the appliance.

- ▶ Do not use harsh or abrasive cleaning agents.
- ▶ Do not use cleaning agents with a high alcohol content.
- ▶ Do not use hard scouring pads or cleaning sponges.
- ▶ Do not use any special cleaners for cleaning the appliance while it is hot.

Salt contained in new sponge cloths may damage surfaces.

- ▶ Wash new sponge cloths thoroughly before use.
- Using oven cleaner in a hot oven cavity damages the stainless steel surfaces.
- ▶ Never use oven cleaner in the oven cavity when it is still warm.
 - ▶ Remove all food remnants from the oven cavity and the appliance door before you next heat up the appliance.

WARNING

Loose food residues, fat, and meat juices may catch fire.

- ▶ Remove coarse dirt from the oven cavity and from the accessories.

Area	Suitable cleaning agents	Information
		<p>Stainless steel cleaner that is suitable for the appliance can be obtained from customer service or online.</p> <p>To prevent corrosion, remove any patches of limescale, grease, starch or albumin (e.g. egg white) from stainless steel surfaces immediately. Corrosion may form under such stains.</p> <p>Do not use oven spray or other aggressive oven cleaners or abrasive materials. Scouring pads, rough sponges and pan cleaners are unsuitable. These items scratch the surface.</p> <p>Always dry the oven cavity after cleaning.</p> <p>→ "Rapid drying", Page 45</p> <p>Note: Undissolved detergent causes patches to appear when heating up and these patches cannot be removed. Thoroughly remove residues from detergents or care products using clean water before drying the oven cavity.</p>
Lightly soiled cooking compartment	<ul style="list-style-type: none"> ▪ Cleaning aid 	The cleaning aid → Page 43 loosens stubborn dirt in the cooking compartment and makes cleaning easier.
Very dirty oven cavity	<ul style="list-style-type: none"> ▪ Cleaning program 	The cleaning program → Page 43 removes stubborn dirt.
Broiling area	<ul style="list-style-type: none"> ▪ Glass ceramic cleaner 	Regularly clean with glass ceramic cleaner. Do not use a glass scraper.
Glass cover for the oven cavity light	<ul style="list-style-type: none"> ▪ Hot soapy water 	Clean with a dish cloth.
Water tank	<ul style="list-style-type: none"> ▪ Hot soapy water ▪ Dishwasher 	<p>To remove residual detergent after cleaning, rinse thoroughly with clean water.</p> <p>Clean in the dishwasher as necessary.</p> <p>Remove the lid and place the water tank upside down in the dishwasher.</p> <p>Note: Before fitting the lid, ensure that the suction hose is free of residues.</p> <p>→ "Check the water tank", Page 49</p> <p>After cleaning, leave the water tank to dry with the lid open.</p>
Shelf supports	<ul style="list-style-type: none"> ▪ Dishwasher ▪ Hot soapy water 	<p>Note: If required, remove the shelf supports for cleaning.</p> <p>→ "Removing the shelf supports", Page 47</p> <p>In the event of heavy soiling, leave to soak and use a brush.</p>
Cooking container, wire rack	<ul style="list-style-type: none"> ▪ Dishwasher ▪ Hot soapy water 	<p>Soak burned-on residues and clean with a brush.</p> <p>Light-colored patches on stainless steel are caused by protein residues. Remove these stains with lemon juice. Rinse thoroughly with clean water.</p>
Core temperature probe	<ul style="list-style-type: none"> ▪ Hot soapy water 	<p>Wipe with a damp cloth</p> <p>Do not clean in the dishwasher.</p>

18.2 Microfiber cloth

The honeycomb microfiber cloth is especially suitable for cleaning easily damaged surfaces, such as glass, glass ceramic, stainless steel or aluminum. The microfiber cloth removes liquid and greasy deposits in one go.

The microfiber cloth can be obtained from customer service or from the online shop.

18.3 Cleaning the drain filter

1. If necessary, clean the drain filter.
When cooking fish or meat, we recommend cleaning the appliance after each use.

2. Turn the drain filter counterclockwise ① and remove it ②.

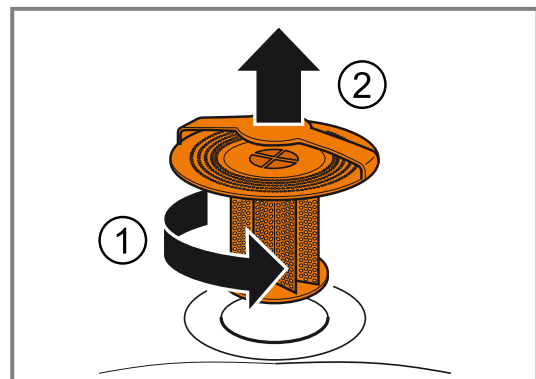

- Remove any food remnants from the drain filter.

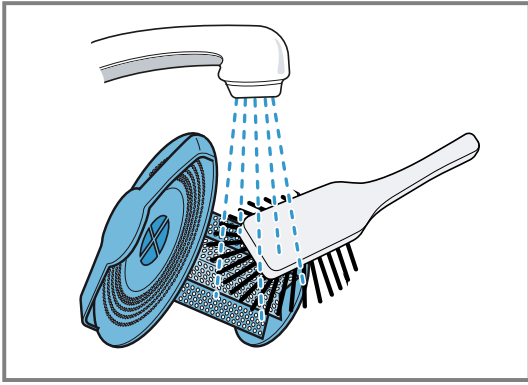

- Rinse out the drain filter under running water. If it is very dirty, clean it in the dishwasher.
- Insert the drain filter and turn it clockwise as far as it will go.

Note: Never operate the combi-steam oven without the drain filter in place.

18.4 Cleaning aid

The cleaning aid loosens stubborn dirt in the cooking compartment and makes cleaning easier. Always allow the cleaning aid to run to the end. You cannot cancel the cleaning aid.

Preparing the cleaning aid

Requirement: The interior oven temperature is below 104°F (40°C).

- Remove all accessories from the oven cavity.
- Remove the shelf supports from the oven cavity. → Page 47
- Clean the accessories and side shelf supports separately.
- Wipe out any coarse dirt.
- Spray and wipe out the oven cavity with a cleaning agent.
- Close the appliance door.

Starting the cleaning aid

Note: The appliance will take you through the necessary steps.

- Swipe repeatedly from left to right until the display shows "Modes & Service".
- ✓ The display shows the available functions in a list menu.
- Use the control ring to select the "Cleaning aid" function.
- Press the "Cleaning aid" list item.
- Switch to the next window with →.
- Press ▶ to start.
- ✓ The cleaning time counts down.
- ✓ The light in the oven cavity remains switched off.
- ✓ An audible signal will sound once the cleaning time has elapsed.
- ✓ The display shows a message.
- Wipe out the oven cavity.
- Clean the drain filter.
- Wipe the oven cavity dry with a soft cloth.

- Before using the oven again, remove any detergent residue from the oven cavity.

- Fit the shelf supports. → Page 47
→ "Fitting the shelf supports", Page 47

Note: If the cleaning aid was canceled due to a power cut, it must be restarted before using the oven again in order to remove any detergent residues from the appliance.



18.5 Cleaning program

The cleaning program removes stubborn dirt using a cleaning cartridge, and cleans, rinses and dries the oven cavity fully automatically. You need special cleaning cartridges for the cleaning program.

NOTICE

Heat may melt the cleaning cartridge and damage the oven cavity.

- ▶ Use cleaning cartridges for the cleaning program only.
- ▶ Never place cleaning cartridges in the oven cavity when it is hot or heat them up in the oven cavity.

Screw a cleaning cartridge  in at the top of the appliance. Ensure that the drain filter remains inserted in the oven cavity floor while the cleaning program is in progress. If you remove the drain filter  before the cleaning program is started, the oven cavity will not be clean.

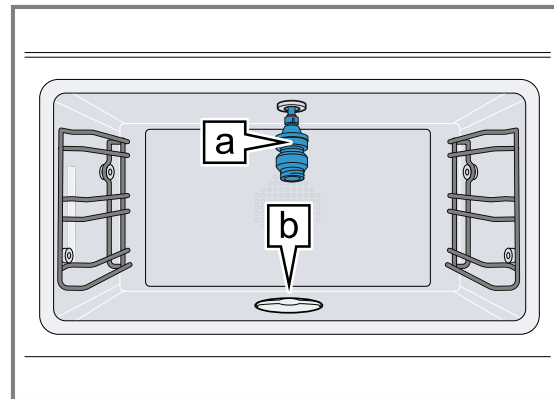

The cleaning cartridges can be obtained from customer service or from the online shop. You can only use the cleaning cartridges once and cannot refill them. Do not use any other cleaner.

The cleaning program takes around 4 hours from beginning to end. The cleaning program runs automatically. With normal use, we recommend cleaning the appliance with the cleaning program four times a year. Depending on the use, more frequent cleaning can be necessary. If there are a lot of food remnants, do not allow them to burn on. Start the cleaning program as soon as the appliance has cooled to 104°F (40°C).

You can check the temperature in the oven cavity by touching the **i** symbol.

You can only restart the cleaning program once the appliance has cooled down to below 104°F (40°C). Remove the cooking containers, core temperature probe and other accessories from the cooking compartment before you start the cleaning program.

Note: To clean the wire rack, you can insert the rack at level 1 and leave it in the oven cavity while the appliance is being cleaned.

The appliance door is locked during the cleaning program. Do not try and open the appliance door during the cleaning program. The water may escape from the oven cavity.

The noise from the appliance fan is louder when the cleaning program is in progress. This is normal.

Always allow the cleaning program to run to the end. You cannot cancel the cleaning program.

Selecting a cleaning program

1. Swipe repeatedly from left to right until the display shows "Modes & Service".
- ✓ The display shows the available functions in a list menu.
2. Use the control ring to select the "Automatic cleaning" function.
3. Press the "Automatic cleaning" list item.
 - ▶ If the cooking compartment temperature is too high, allow the appliance to cool.

Selecting the switch-off time

Requirement: The display shows the switch-off time at which the appliance ends the cleaning program.

- ▶ If required, you can use the control ring to delay the switch-off time.
- ✓ The appliance moves the start time and switch-off time. The cleaning time remains the same.

Preparing the appliance for the cleaning program

⚠ WARNING

The cleaning agent solution may cause chemical burns in the mouth, throat and eyes or on the skin.

- ▶ Follow the safety instructions on the packaging of the cleaning cartridges.
- ▶ Do not drink the cleaning agent solution.
- ▶ The cleaning agent solution must not come into contact with food.
- ▶ Clean the water tank in the dishwasher before you next use the appliance.
- ▶ Dispose of the empty cleaning cartridge in accordance with regional regulations for household garbage.

NOTICE

Heat may damage the inserted cartridge.

- ▶ Never heat the appliance if you have inserted the cartridge.

1. Remove all accessories from the oven cavity.
2. Remove coarse dirt.
3. Switch to the next window with →.

4. Ensure that the drain filter remains inserted in the oven cavity floor while the cleaning program is in progress.

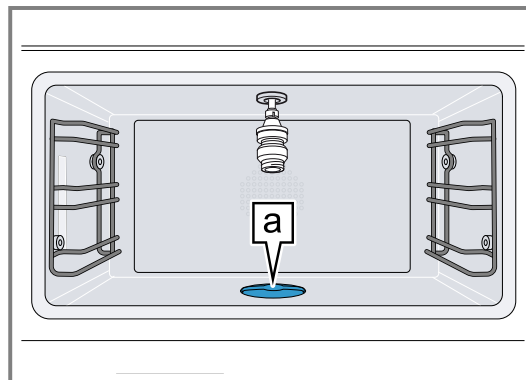

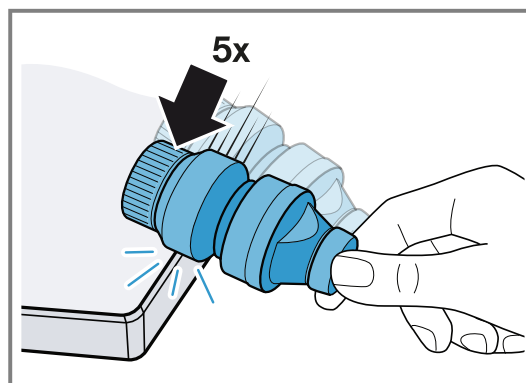

If you remove the drain filter  before the cleaning program is started, the oven cavity will not be clean.

5. Switch to the next window with →.
6. To dissolve the cleaning powder in the cleaning cartridge, lightly tap the cleaning cartridge against the countertop.

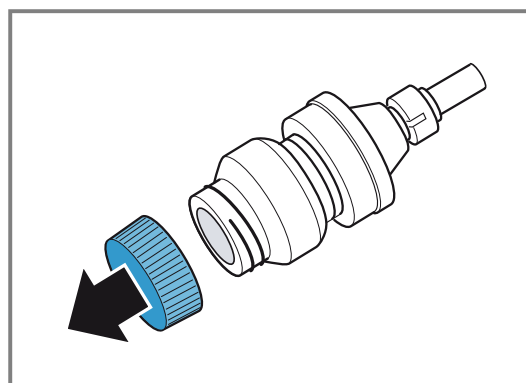

7. Remove the locking cap from the cleaning cartridge.
 - ▶ Do not remove the wax plug from the opening of the cleaning cartridge.
 - ▶ Do not use any other cleaning agents.
 - ▶ Do not use damaged cleaning cartridges.



8. Screw the cleaning cartridge  fully into the socket in the top of the oven cavity.

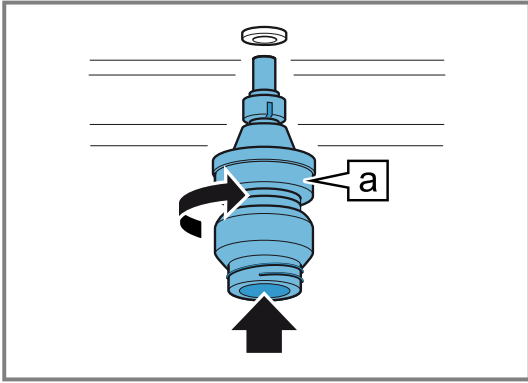

Starting the cleaning program

1. Close the appliance door.
 2. Press ✓ to confirm.
 3. Press ▶ to start.
- ✓ The switch-off time counts down on the display. The cleaning duration counts down on the display.
 - ✓ The light in the oven cavity remains switched off.
 - ✓ The appliance door is locked.
 - ✓ After around 3 hours 40 minutes, the display shows a message.

Ending the cleaning program

1. Remove the cleaning cartridge.
2. Turn the drain filter in the oven cavity floor counter-clockwise ① and remove it ②.

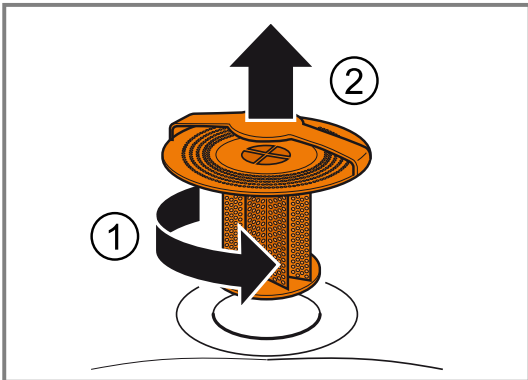

3. Remove any food remnants from the drain filter.
4. Rinse out the drain filter under running water.

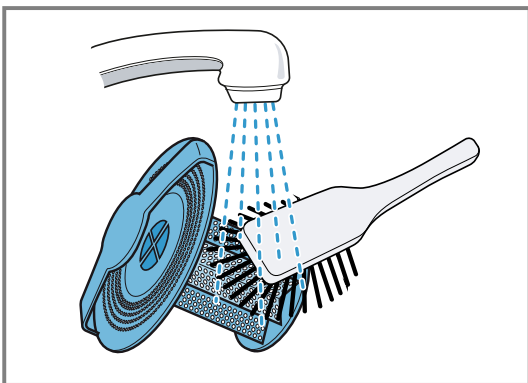

5. Switch to the next window with →.
6. Press ✓ to confirm.
- ✓ The cleaning program is complete.
7. Allow the appliance to cool down.

8. Polish the oven cavity and door pane with a soft cloth.
 - ▶ If required, remove the white streaks in the oven cavity and on the door pane with a damp cloth. Depending on the water hardness, the final rinse may leave white streaks in the oven cavity and on the door pane after drying.
9. Dispose of the empty cleaning cartridge in accordance with regional regulations for household garbage.

Causes of an unsatisfactory cleaning result

Note the causes of an unsatisfactory cleaning result.

WARNING

The cleaning agent solution may cause chemical burns in the mouth, throat and eyes or on the skin.

- ▶ To prevent the detergent from coming into contact with your skin or eyes, do not remove the locking cap from a spent cartridge.

Possible cause	Solution
The locking cap is still on the cleaning cartridge.	After the end of the cleaning program, remove the cleaning cartridge from the appliance. Do not reuse the cleaning cartridge. Dispose of the cleaning cartridge in accordance with the regional regulations.
The drain filter is missing.	Ensure that the drain filter remains inserted in the cooking compartment floor while the cleaning program is in progress.
The power has failed.	Following a power outage, the appliance ends the cleaning program with a short program.
Dirt is heavily baked on.	Run the cleaning program again to remove stubborn dirt.
After cleaning, there is still cleaning agent residue in the cleaning cartridge.	Repeat the cleaning with a new cleaning cartridge. Before cleaning, tap the cleaning cartridge against the countertop with more force.

18.6 Rapid drying

You can use the "Rapid drying" function to dry the cooking compartment quickly after cleaning or steaming.

NOTICE

Heat damages the water tank.

- ▶ Do not dry the water tank in the hot oven cavity.

The "Rapid drying" function lasts 15 minutes.

Starting "Rapid drying"

Requirement: The appliance door is closed.

1. Swipe repeatedly from left to right until the display shows "Modes & Service".
- ✓ The display shows the available functions in a list menu.

2. Use the control ring to select the "Rapid drying" function.
3. Press "Start".
4. If required, change the end time for the drying time.
 - ▶ Use the control ring to change the end time for the drying time.
5. Switch to the next window with →.
6. Follow the instructions in the notification texts.
7. Press ▶ to start.
 - ✓ The display shows 15 minutes for the drying time and 355°F (180°C).
 - ✓ If you have selected the start of the drying time, the display shows → and the time for the start of the drying time.
 - ✓ The display shows the drying time that has elapsed.
 - ✓ The interior lighting remains switched off.
 - ✓ A signal sounds after 15 minutes.
 - ✓ The display shows a message.
 - ✓ The "Rapid drying" has finished.
8. Press ✓ to confirm.
 - ✓ The display shows the start screen.
9. Allow the appliance to cool down.
10. Polish the oven cavity and door pane with a soft cloth.

Ending "Rapid drying"

- ▶ Press ■.
- ✓ The appliance ends the "Rapid drying" function.

18.7 Descaling program

You can use the descaling program to descale the appliance fully automatically. If you descale the appliance regularly, your appliance will be in a good condition.

NOTICE

Limescale may damage the appliance.

- ▶ Descale the appliance regularly.
- Using the wrong descaler may damage the appliance.
- ▶ Only use the specified descaling tablets.
- The descaling tablet may damage the oven cavity.
- ▶ Use the descaling tablet for the descaling program only.
 - ▶ Place the descaling tablet into the water tank.
 - ▶ Never place the descaling tablet in the oven cavity or heat it up in the oven cavity.

The descaling tablets can be obtained from customer service, our website or the online shop. Depending on the water hardness and the use of the appliance, a message on the display reminds you to run the descaling program. To prevent damage to the appliance, the appliance locks the operating modes that use steam after this message has been repeated. You can still use the appliance to run operating modes that do not require steam. You can only use the appliance without any restrictions after you have run the descaling program. The descaling program takes 1 hour 50 minutes from beginning to end. After 1 hour 30 minutes, empty, clean and refill the water tank.

Activating and preparing the descaling program

1. Swipe repeatedly from left to right until the display shows "Modes & Service".
 - ✓ The display shows the available functions in a list menu.
2. Use the control ring to select the "Automatic descaling" function.
 - You cannot cancel the descaling program. Always allow the descaling program to run to the end.
3. Move the switch to "On".
4. Follow the instructions in the notification texts.
5. Use the control ring to select "End time".
6. Press the preset end time.
7. Use the control ring to change the end time for the descaling.
8. Press <.
- ✓ The end time for the descaling has been set.
9. Remove all accessories from the oven cavity.
10. Remove the water tank from the appliance and take off the lid.
11. Remove the descaling tablet from the plastic packaging.
12. Place the descaling tablet in the compartment at the back of the water tank.

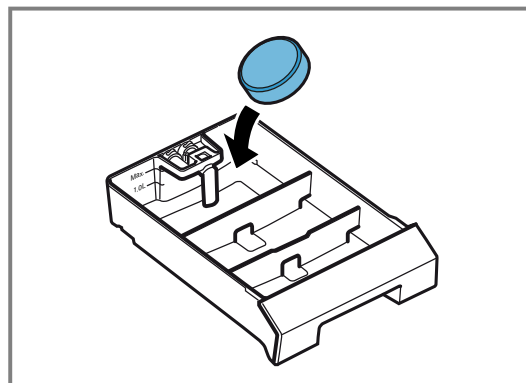

13. Position the lid on the tank and click it into place.
14. Fill the water tank up to the "Max." mark with 1.7 l cold water.

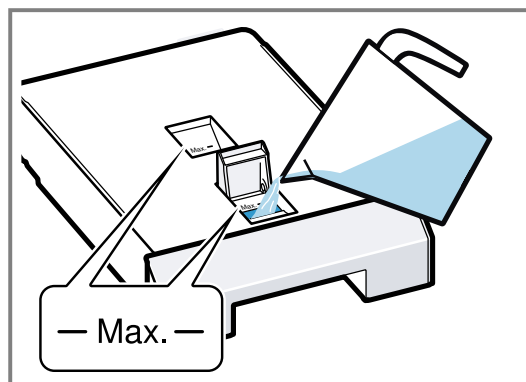

15. Slide the water tank back in as far as it will go.

Starting the descaling program

1. Close the appliance door.
2. Use ✓ to confirm the last notification.

3. Press ▶ to start.
 - ✓ The display shows the descaling time as 1.5 hours.
 - ✓ The descaling time counts down on the display.
 - ✓ If you have selected a switch-off time, the switch-off time counts down on the display.
 - ✓ The light in the oven cavity remains switched off.
 - ✓ After approximately 1 hour 30 minutes, the display shows a message.
4. Clean the water tank and refill it with fresh water.

Continuing the descaling program

⚠ WARNING

The descaling solution may cause chemical burns in the mouth, throat and eyes or on the skin.

- ▶ Avoid the skin coming into contact with the descaling solution.
- ▶ Keep children away from the descaling solution.
- ▶ Do not drink the descaling solution.
- ▶ The descaling solution must not come into contact with food.
- ▶ Clean the water tank in the dishwasher or thoroughly by hand before you next use the appliance.

Requirement: The display shows a message that the appliance has canceled the program.

1. Empty the water tank, thoroughly clean it and slide it into the appliance.
2. Press →.
- ✓ The appliance starts the rinsing process.
3. Follow the instructions in the notification texts and press →.
- ✓ Once the descaling program has ended, a signal tone sounds.
4. Use ✓ to confirm the last notification.
5. Clean the water tank and refill it with fresh water.

Cleaning the water tank

After the descaling program, remove the descaling residue from the water tank.

1. Remove the water tank from the appliance.
2. Remove the tank lid.
3. Clean the water tank and the tank lid in the dishwasher or thoroughly by hand.

18.8 Removing the shelf supports

1. Place a dishcloth in the oven cavity to protect the stainless steel from scratches.

2. Undo the knurled nuts.

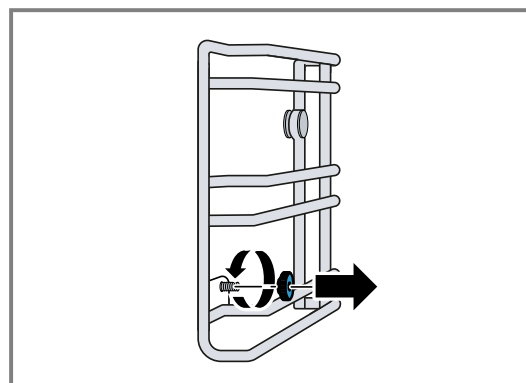

3. Lift the shelf supports slightly sideways away from the screw ① and pull them out towards the front ②.

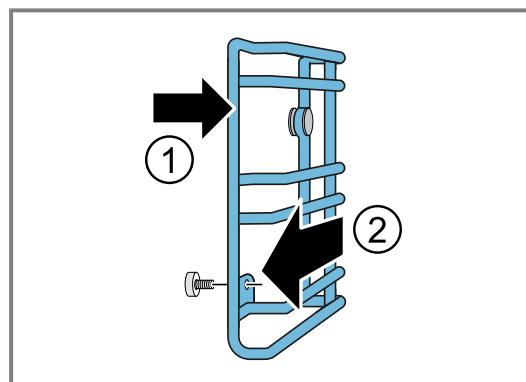

4. Clean the shelf supports in hot soapy water or in the dishwasher.

18.9 Fitting the shelf supports

NOTICE

Incorrect spare parts may lead to corrosion in the oven cavity.

- ▶ Only use the original knurled nuts.

1. Fit the shelf supports on the correct side of the cooking compartment.
The shelf supports for the left and right side of the cooking compartment are different.
2. Slide the back of the shelf supports onto the bolts and attach them at the front.
3. Tighten the knurled nuts.

Note: If you lose a knurled nut, you can order this as a spare part from our customer service.

19 Troubleshooting



You can eliminate minor issues on your appliance yourself. Please read the information on eliminating issues before contacting Customer Service. This may avoid unnecessary repair visits.

⚠ WARNING

To avoid risk of injury from improper repairs, observe the following.



- ▶ Only qualified technicians or authorized service providers should perform repairs.
- ▶ If the power cord of this appliance becomes damaged, it must be replaced by the manufacturer, the manufacturer's Customer Service, or an authorized service provider in order to prevent injury.
- ▶ Only genuine spare parts may be used to repair the appliance.
- ▶ If the appliance has an issue, call Customer Service.

19.1 Malfunctions

Fault	Cause and troubleshooting
The appliance is not working.	<p>The plug for the power cord is not plugged in.</p> <ul style="list-style-type: none"> ▶ Connect the appliance to the power supply. <hr/> <p>The circuit breaker in the circuit breaker panel has tripped.</p> <ul style="list-style-type: none"> ▶ Check the breaker panel. <hr/> <p>There has been a power failure.</p> <ul style="list-style-type: none"> ▶ Check whether the lighting in your kitchen or other appliances in the room are working. <hr/> <p>Operating error.</p> <ul style="list-style-type: none"> ▶ Switch off the circuit breaker for the appliance in the fuse box and switch it back on after approximately 60 seconds.
The appliance is not working. Display shows "Appliance locked. Descaling required."	<p>Build-up of limescale in the appliance.</p> <ul style="list-style-type: none"> ▶ Start the descaling program → <i>Page 46</i>.
Despite descaling, "Please descale" appears on the display.	<p>Build-up of limescale in the appliance, incorrect descaler used.</p> <ol style="list-style-type: none"> 1. Use the specified descaling tablets. 2. Start the descaling program → <i>Page 46</i>.
The appliance does not start.	<p>The appliance door is not fully closed.</p> <ul style="list-style-type: none"> ▶ Close the appliance door.
The appliance cannot be started via the Home Connect® app.	<p>The appliance is not connected to the Home Connect® app.</p> <ul style="list-style-type: none"> ▶ Start the connection between the appliance and the Home Connect® app. → <i>"Setting up Home Connect®", Page 33</i> <hr/> <p>The appliance is connected to the Home Connect® app but the remote control function is not activated.</p> <ul style="list-style-type: none"> ▶ Activate the remote control function in the Home Connect settings → <i>Page 34</i>.
The appliance is not working. The display shows E5117.	<p>The appliance does not receive water.</p> <ol style="list-style-type: none"> 1. Check the water tank. → <i>Page 49</i> 2. If the display shows the error message again, contact customer service → <i>Page 52</i>.
The appliance is not working. The display does not respond. The display shows the symbol for the childproof lock  .	<p>Childproof lock is activated.</p> <ul style="list-style-type: none"> ▶ Deactivate the childproof lock. → <i>Page 27</i>
The appliance automatically switches off.	<p>Safety switch-off function: No operation for more than 12 hours.</p> <ol style="list-style-type: none"> 1. Press ✓ to confirm the message. 2. Switch off the appliance.
The appliance does not heat up; the display shows the symbol for the demo mode  .	<p>The appliance is in demo mode.</p> <ul style="list-style-type: none"> ▶ Deactivate the demo mode in the basic settings → <i>Page 35</i>.
No steam is visible.	<p>Water vapor above 100 °C is not visible.</p> <ul style="list-style-type: none"> ▶ This is normal. <p>No action required.</p>
Powerful steam release at the top of the door.	<p>You have changed the operating mode.</p> <ul style="list-style-type: none"> ▶ This is normal. <p>No action required.</p>
Powerful steam release at the side of the door.	<p>The door seal is dirty or loose.</p> <ol style="list-style-type: none"> 1. Clean the door seal. 2. Insert the door seal into the groove.
Humming noise when switching on.	<p>The drain pump starts running.</p> <ul style="list-style-type: none"> ▶ Normal operating noise <p>No action required.</p> <hr/> <p>The appliance has been switched off for a few days. Automatic rinsing during initial use.</p> <ul style="list-style-type: none"> ▶ Normal: Automatic rinsing during initial use. <p>No action required.</p>
A whistling noise occurs during heating.	<p>Noises may occur during steam generation.</p> <ul style="list-style-type: none"> ▶ This is normal.

Fault	Cause and troubleshooting
A whistling noise occurs during heating.	No action required.
A "plop" sound can be heard during cooking.	Tension expansion when the temperature difference is large. ▶ This is normal. No action required.
Steaming is not possible.	Build-up of limescale in the appliance. The appliance must be descaled to avoid damage to the appliance. ▶ Start the descaling program → <i>Page 46</i> .
The appliance is no longer producing steam correctly.	Build-up of limescale in the appliance. ▶ Start the descaling program → <i>Page 46</i> .
The lighting does not work.	The lighting is defective. 1. Switch off the fuse in the fuse box. 2. Switch the fuse on after approx. 10 seconds. 3. If the malfunction occurs again, call customer service.
Water drips out when you open the appliance door.	The collecting channel on the underside of the door pane is full. ▶ Dry the collecting channel with a sponge.
An unpleasant smell occurs during heating.	The appliance is new. ▶ Before using it for the first time, heat the appliance at 60% humidity $\frac{4}{5}$ and 200 °C for one hour.



19.2 Display information

Fault	Cause and troubleshooting
Display shows  .	The water tank is not OK. 1. Press  .
Display shows "Cleaning aid program terminated. Wipe out the cooking compartment. Remove cleaning agent residues."	The appliance was switched off during the cleaning aid program or the power supply was disconnected. 1. Fill the water tank. 2. Wipe out the cooking compartment. 3. Restart the cleaning aid program.
The display shows the error message "Exx".	An error occurred. 1. If the display shows an error message, press  . ✓ If the display no longer shows the error message, it was a one-off problem. 2. If the display continues to show or repeatedly shows the error message, contact customer service → <i>Page 52</i> and provide them with the error code.

19.3 Check the water tank

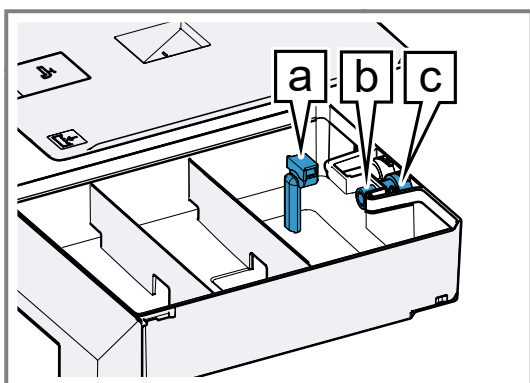
1. Remove the right-hand water tank.
2. Remove the tank lid.
3. Remove the suction hose  towards the rear of the water tank and clean it under running water.



4. Check whether the suction hose is free of residues.
5. Check whether the filter  is free of residues at the discharge valve  towards the rear of the water tank.

6. Fully fit the suction hose .
▶ Ensure that the suction hose is not kinked.

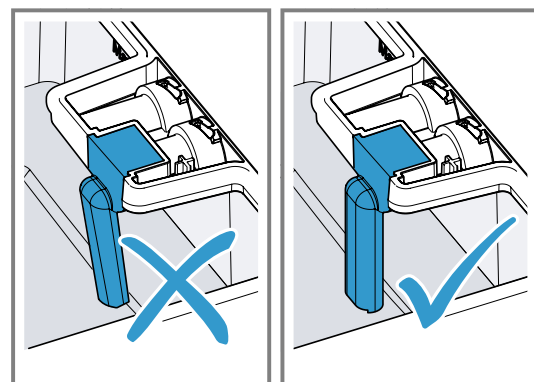

7. Fit the tank lid.

19.4 Demo mode

If the display shows , demo mode is activated. The appliance does not heat up.

Deactivating demo mode

1. To briefly disconnect the appliance from the mains, switch off the household fuse or the circuit breaker in the fuse box.
2. Deactivate demo mode within 3 minutes in the basic settings → *Page 35*.

20 How it works

Here, you can find the ideal settings for various types of food as well as the best accessories and cookware. We have perfectly tailored these recommendations to your appliance.

You can find recommended settings → *Page 29* for some meals in the display under Programs → *Page 28* or in the Home Connect® app.

The following overview only contains standard dishes for test purposes.

20.1 General cooking tips

Take note of the following information when cooking all types of food.

- The cooking times specified are intended as a guide. The actual cooking time depends on the quality and temperature of the food before cooking, as well as its weight and thickness.
- The values given refer to average quantities for 4 people. If you want to prepare a larger amount, expect a longer cooking time.
- Use the cookware specified. If you use other cookware, cooking times may be longer or shorter.
- Always use plates, baking tins or ovenproof dishes with the wire rack.
- If you have not made a particular dish before, start with the shortest specified time. If required, you can continue to cook the food.
- Open the oven cavity door on the preheated oven for a short time only and quickly place your food inside the appliance.
- When steaming, defrosting, dough proving and reheating, you can use up to 3 shelf levels at a time (shelf levels 1, 2 and 3). This will not cause flavor to transfer. You can therefore cook fish, vegetables and desserts at the same time. The specified cooking times may need to be extended for large quantities of food.
- If you are only baking on one level, use level 2. If you are baking on two levels at the same time, use levels 1 and 3.
- Ensure that the food does not lie against the oven cavity or the back panel.
- The appliance door must shut properly. Keep the seal surfaces clean at all times.
- To ensure optimal steam circulation, do not position the racks and containers too closely.
- When cooking very cold foods and when cooking at high temperatures, the cooking container may deform. This deformation does not impair its performance. When the cooking container cools down again, it returns to its original shape.
- If the appliance is above 210 °F (100 °C), allow the appliance to cool down before steaming. Otherwise, the high temperature causes the food to dry out.

- When steaming at temperatures up to 210 °F (100 °C), no preheating is necessary. Place the food in the cold oven cavity and then switch on the appliance.
- The estimated cooking time starts as soon as the cooking compartment reaches the selected temperature.
- Always preheat the appliance. This will produce the best cooking results. The cooking times specified refer to a preheated appliance.

20.2 Sous-vide cooking

When sous-vide cooking, you cook the food under a vacuum at low temperatures between 120-200 °F (50-95 °C) and at 100% steam.

WARNING

Due to the low sous-vide cooking temperatures, there is a risk to health if you do not follow the instructions for use and hygiene instructions below.

- ▶ Use only fresh, good-quality food.
- ▶ Wash and disinfect your hands. Use disposable gloves or grill tongs.
- ▶ Take extra care when preparing critical food, such as poultry, eggs and fish.
- ▶ Always thoroughly rinse and/or peel fruit and vegetables where necessary.
- ▶ Always keep countertops and chopping boards clean. Use different chopping boards for different types of food.
- ▶ Maintain the cold chain. Only interrupt the cold chain briefly to prepare the food. Store vacuum-sealed food back in the refrigerator until it is ready to be cooked.
- ▶ The food is suitable for immediate consumption only. Once the food is cooked, consume it immediately. Do not store it after cooking. Do not store the food in the refrigerator either. The food is not suitable for reheating.
- Sous-vide cooking is a gentle, low-fat method of cooking meat, fish, vegetables and desserts. A vacuum-sealing machine uses heat to hermetically seal the food in a special heat-resistant cooking bag.
- The protective envelope retains the nutrients and flavors. The low temperatures and the direct heat transfer help you to achieve precisely controlled cooking in order to achieve the desired cooking results. It is almost impossible to overcook the food.
- Use the portion sizes listed in the cooking table. For larger quantities and items, adjust the cooking time accordingly. The portions given for fish, meat and poultry correspond to a single serving. The portions specified for vegetables and desserts correspond to servings for 4 people.
- You can cook on up to two levels. Slide the cooking containers in at levels 1 and 3 to achieve the best

cooking results. If you are cooking on just one level, use level 2.

- When using the sous-vide cooking method, only use heat-resistant vacuum-pack bags designed for this purpose. Do not cook the food in the vacuum-sealing bag in which you bought the food, e.g. portioned fish. These bags are not suitable for sous-vide cooking.
- To ensure an even transfer of heat and a perfect cooking result, use a chamber vacuum-sealing machine that can create a 99% vacuum when vacuum-sealing food.
- With the "Sous-vide cooking" type of heating, it is not possible to postpone the end of the cooking time for hygiene reasons.

Vacuum-sealing

When vacuum-sealing, heat-seal the food in a special plastic bag so that it is airtight.

Note the following points when vacuum-sealing:

- There is no/hardly any air in the vacuum-sealing bag.
- The heat-sealed seam is perfectly sealed.
- The vacuum-sealing bag has no holes in it. Do not use a core temperature probe.
- Pieces of meat or fish that have been vacuum-sealed together are not pressed directly against one another.
- You have vacuum-sealed vegetables and desserts as flat as possible.

Before cooking the food, check whether the vacuum in the bag is intact.

If in doubt, place the food into a new bag and vacuum-seal it again. Vacuum-seal food no more than one day before the cooking process. This is the only way to prevent the escape of gases from the food (e.g. from vegetables) which inhibit the transfer of heat, or to prevent the texture of the food from changing, and thus altering how it cooks, as a result of the vacuum pressure.

Quality of the food

The quality of the cooking result is 100% influenced by the quality of the ingredients you use.

Use only fresh, top-quality food. This is the only way to guarantee a consistent cooking result that delivers impeccable flavor.

Preparation

Sous-vide cooking prevents flavors from escaping, intensifying the food's natural flavor. Note that the usual quantities of seasoning and condiments, such as herbs, spices and garlic, will have a much greater effect on the flavor. Start off by halving the quantities you usually use. If the ingredients are of high quality, it is often sufficient to enclose them in the bag with just a small knob of butter and a little salt and pepper. Generally, the fact that

the food's natural flavors intensify during cooking is sufficient on its own to produce a flavorful cooking result. Do not place the vacuum-sealed food items on top of one another or too close together in the cooking containers. To ensure even heat distribution, make sure that you do not touch the food. If you have more than one vacuum-sealing bag, cook on two levels.

Remove the vacuum-sealing bags with care after cooking, as hot water accumulates on the bags. Place the unperforated cooking container into the oven cavity at the level below the perforated cooking container containing the hot food.

Dry the outside of the bag, place it into a clean, unperforated cooking container and cut it open with scissors. Place all of the food, along with its juices, into the cooking container.

The food can be finished off as follows once the sous-vide cooking stage is complete:

- **Vegetables:** Flash fry in a frying pan or on the teppan yaki to give them the flavors you would expect from frying. In doing so, you can effortlessly season the vegetables or mix them with other ingredients without the vegetables cooling down.
- **Fish:** Season and coat with hot butter. Since many types of fish fall apart easily after cooking using the sous-vide method, if you want to flash fry fish, this should be done before the sous-vide cooking stage. Fry the food for longer if it has not been sufficiently well cooked during the sous-vide cooking stage.
- **Meat:** Flash fry at a very high temperature for a few seconds only on each side. This gives the meat a nice crust and the flavors you would expect from frying, without overcooking it. You can achieve a particularly good result using a teppan yaki or under the grill.

Note: Dab the meat with a dish towel before placing it into hot oil, in order to avoid fat spitting out of the pan.

Serve the food on pre-heated plates and, if possible, with a hot sauce or butter as sous-vide cooking takes place at relatively low temperatures.

20.3 Preparing bulky food

Recommendation for preparing bulky food.

- To prepare bulky food items, you can remove the shelf supports at both sides.
- To do this, undo the knurled nuts at the front of the shelf supports, and pull the shelf supports out towards the front.
- Place the rack directly onto the bottom of the cooking compartment and place the food or roaster onto the rack. Do not place the food or roaster directly onto the bottom of the oven cavity. If required, remove the shelf supports. → *Page 47*

21 Transportation, storage and disposal

21.1 Disposal of your old appliance

Environmentally compatible disposal allows valuable raw materials to be recycled.

1. Unplug the appliance from the power supply.

2. Cut through the power cord.

3. Dispose of the appliance in an environmentally responsible manner.

Information about current disposal methods can be obtained from your specialist dealer or local authority.

22 Customer Service

With any warranty repair, we will make sure your appliance is repaired by an authorized service provider using genuine replacement parts. We use only genuine replacement parts for all repairs.

You can obtain function-relevant and storable genuine spare parts from our Customer Service for up to 15 years from the date on which your appliance was placed on the market.

For more information, please contact our Customer Service team.

Detailed information on the warranty period and terms of warranty can be found in the Statement of Limited Product Warranty, from your retailer, or on our website.

The LED light sources are available as a spare part and should only be replaced by an authorized service provider.

USA:

1-877-442-4436

www.gaggenau.com

www.gaggenau.com/us/appliances/eshop

CA:

1-877-442-4436

www.gaggenau.com

www.gaggenau.ca

For assistance with connecting to Home Connect®, you can also view instructions here:

www.home-connect.com/us/en/help-support/set-up

22.1 Model number (E-Nr.), production number (FD) and consecutive numbering (Z-Nr.)

If you contact Customer Service, you will need the product number (E-Nr.), production number (FD), and con-

secutive numbering (Z-Nr.), which you can find on the appliance's rating label.

You can see the rating plate with these numbers when you open the appliance door.

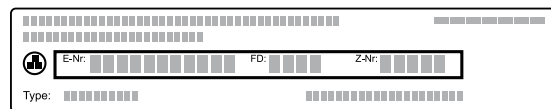

Making a note of your appliance's details and the Customer Service telephone number will enable you to find them again quickly.

22.2 Rating plate location

The rating plate is located at the door frame close to the lower door hinge.

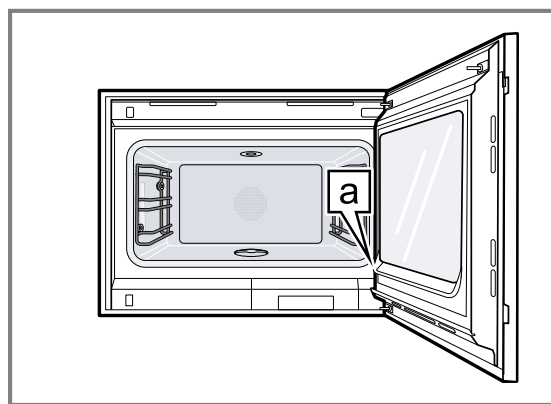

a Rating plate

23 Information regarding Free and Open Source Software

This product includes software components that are licensed by the copyright holders as free or open source software.

The applicable license information is stored on your home appliance. You can also access the applicable license information via your Home Connect® app: "Profile -> Legal information -> License Information".¹ You can also download the license information on the brand product website. (Please search on the product website for your appliance model and additional documents). Alternatively, you can request the relevant information from ossrequest@bshg.com or BSH Hausgeräte GmbH, Carl-Wery-Str. 34, 81739 Munich, Germany.

The relevant source code will be made available to you on request.

Please send your request to ossrequest@bshg.com or BSH Hausgeräte GmbH, Carl-Wery-Str.34, 81739 Munich, Germany.

Subject: „OSSREQUEST“

The cost of performing your request will be charged to you. This offer is valid for three years from the date of

purchase or at least as long as we offer support and spare parts for the relevant appliance.

¹ Depending on the appliance specifications

24 STATEMENT OF LIMITED PRODUCT WARRANTY

24.1 What this warranty covers & Who it applies to

The limited warranty provided by BSH Home Appliances (“Gaggenau”) in this Statement of Limited Product Warranty applies only to the Gaggenau appliance sold to you (“Product”), provided that the Product was purchased on or after January 1, 2025:

- For your normal, household (non-commercial) use, and has in fact at all times only been used for normal household purposes.
- New at retail from a BSH authorized dealer or directly from BSH (not a display, "as is", or previously returned model), and not for resale, or commercial use.
- Within the United States or Canada, and has at all times remained within the country of original purchase.

The warranties stated herein apply to the original purchaser of the product warranted herein and to each succeeding owner of the product purchased for ordinary home use during the term of the warranty.

Please make sure to register your Product; while not necessary to effectuate warranty coverage, it is the best way for Gaggenau to notify you in the unlikely event of a safety notice or product recall.

24.2 How long the warranty lasts

Gaggenau warrants that the Product is free from defects in materials and workmanship for a period of five (5) years from the date of the original delivery. The warranty shall only be extended for the time that elapsed between the date of your warranty claim and the date of the completed repair or replacement. This Product is also warranted to be free from **cosmetic** defects in material and workmanship (such as scratches of stainless steel, paint/porcelain blemishes, chips, dents, or other damage to the finish) of the Product, for a period of sixty (60) days from the date of delivery or closing date for new construction. This **cosmetic** warranty excludes slight color variations due to inherent differences in painted and porcelain parts, as well as differences caused by kitchen lighting, product location, or other similar factors. This **cosmetic** warranty specifically excludes any display, floor, “As Is”, or “B” stock appliances.

24.3 Repair/replace as your exclusive remedy

During this warranty period, Gaggenau or one of its authorized service providers will repair your Product without charge to you (subject to certain limitations stated herein) if your Product proves to have been manufactured with a defect in materials or workmanship. If reasonable attempts to repair the Product have been made without success, then Gaggenau will replace your Product (upgraded models may be available to you, in Gaggenau's sole discretion, for an additional charge). Nothing in this warranty requires damaged or defective parts to be replaced with parts of a different type or design than the original parts. All removed parts and com-

ponents shall become the property of Gaggenau at its sole option. All replaced and/or repaired parts shall assume the identity of the original part for purposes of this warranty and this warranty shall not be extended with respect to such parts. Gaggenau's sole liability and responsibility hereunder is to repair manufacturer-defective Product only, using a Gaggenau authorized service provider during normal business hours. For safety and property damage concerns, Gaggenau highly recommends that you do not attempt to repair the Product yourself, or use a non-authorized service provider; Gaggenau will have no responsibility or liability for damage resulting from repairs or work performed by a non-authorized service provider. Authorized service providers are those persons or companies that have been specially trained on Gaggenau products, and who possess, in Gaggenau's opinion, a superior reputation for customer service and technical ability (note that they are independent entities and are not agents, partners, affiliates or representatives of Gaggenau). Nevertheless, taking your product to be serviced by a repair shop that is not affiliated with or an authorized dealer of Gaggenau will not void this warranty. Also, using third-party parts will not void this warranty. Notwithstanding the foregoing, Gaggenau will not incur any liability, or have responsibility, for the Product if it is located in a remote area (more than 100 miles from an authorized service provider) or is reasonably inaccessible, hazardous, threatening, or treacherous locale, surroundings, or environment; in any such event, if you request, Gaggenau would still pay for labor and parts and ship the parts to the nearest authorized service provider, but you would still be fully liable and responsible for any travel time or other special charges by the service company, assuming they agree to make the service call. Further, to the extent you have installed the Product in a difficult-to-access location or have otherwise installed temporary or permanent fixtures that create barriers to accessing or removing the Product, Gaggenau will not incur any liability for, or have responsibility, for work or costs associated with moving the Product or otherwise creating access to the Product in order to repair or replace it. All such costs shall be your sole responsibility.

24.4 Out of warranty product

Gaggenau is under no obligation, at law or otherwise, to provide you with any concessions, including repairs, prorates, or Product replacement, once this warranty has expired.

24.5 Warranty exclusions

The warranty coverage described herein excludes all defects or damage that are not the direct fault of Gaggenau, including without limitation, one or more of the following:

- Use of the Product in anything other than its normal, customary and intended manner (including without limitation, any form of commercial use, use or storage of an indoor product outdoors, use of the Product in conjunction with air or water-going vessels).

- Any party's willful misconduct, negligence, misuse, abuse, accidents, neglect, improper operation, failure to maintain, improper or negligent installation, tampering, failure to follow operating instructions, mishandling, unauthorized service (including selfperformed "fixing" or exploration of the appliance's internal workings).
- Adjustment, alteration or modification of any kind.
- A failure to comply with any applicable state, local, city, or county electrical, plumbing and/or building codes, regulations, or laws, including failure to install the product in strict conformity with local fire and building codes and regulations.
- Ordinary wear and tear, spills of food, liquid, grease accumulations, or other substances that accumulate on, in, or around the Product.
- Any external, elemental and/or environmental forces and factors, including without limitation, rain, wind, sand, floods, fires, mud slides, freezing temperatures, excessive moisture or extended exposure to humidity, lightning, power surges, structural failures surrounding the appliance, and acts of God.
- Service calls to correct the installation of your Product, to instruct you how to use your Product, to replace house fuses or correct house wiring or plumbing.
- Removal and replacement of trim or decorative panels that interfere with servicing the Product.
- Damage or defects caused by labor or parts installed by any non-authorized service provider, unless approved by Gaggenau before service is performed.

In no event shall Gaggenau have any liability or responsibility whatsoever for damage to surrounding property, including cabinetry, floors, ceilings, and other structures or objects around the Product. Also excluded from this warranty are Products, on which the serial numbers have been altered, defaced, or removed; service visits to teach you how to use the Product, or visits where there is nothing wrong with the Product; correction of installation problems (you are solely responsible for any structure and setting for the Product, including all electrical, plumbing or other connecting facilities, for proper foundation/flooring, and for any alterations including without limitation cabinetry, walls, floors, shelving, etc.); and resetting of breakers or fuses.

TO THE EXTENT ALLOWED BY LAW, THIS WARRANTY SETS OUT YOUR EXCLUSIVE REMEDIES WITH RESPECT TO PRODUCT, WHETHER THE CLAIM ARISES IN CONTRACT OR TORT (INCLUDING STRICT LIABILITY, OR NEGLIGENCE) OR OTHERWISE. THIS WARRANTY IS IN LIEU OF ALL OTHER WARRANTIES, WHETHER EXPRESS OR IMPLIED. ANY WARRANTY IMPLIED BY LAW, WHETHER FOR MERCHANTABILITY OR FITNESS FOR A PARTICULAR PURPOSE, OR OTHERWISE, SHALL BE EFFECTIVE ONLY FOR THE PERIOD THAT THIS EXPRESS LIMITED WARRANTY IS EFFECTIVE. IN NO EVENT WILL THE MANUFACTURER BE LIABLE FOR CONSEQUENTIAL, SPECIAL, INCIDENTAL, INDIRECT, "BUSINESS LOSS", AND/OR PUNITIVE DAMAGES, LOSSES, OR EXPENSES, INCLUDING WITHOUT LIMITATION TIME AWAY FROM WORK, HOTELS AND/OR RESTAURANT MEALS, REMODELLING EXPENSES IN EXCESS OF DIRECT DAMAGES WHICH ARE DEFINITELY CAUSED EXCLUSIVELY BY GAGGENAU, OR OTHERWISE. SOME STATES DO NOT ALLOW THE EX-

CLUSION OR LIMITATION OF INCIDENTAL OR CONSEQUENTIAL DAMAGES, AND SOME STATES DO NOT ALLOW LIMITATIONS ON HOW LONG AN IMPLIED WARRANTY LASTS, SO THE ABOVE EXCLUSIONS OR LIMITATIONS MAY NOT APPLY TO YOU. THIS WARRANTY GIVES YOU SPECIFIC LEGAL RIGHTS, AND YOU MAY ALSO HAVE OTHER RIGHTS WHICH VARY FROM STATE TO STATE.

No attempt to alter, modify or amend this warranty shall be effective unless authorized in writing by an officer of BSH.

24.6 Obtaining warranty service

To obtain warranty service for your product, you should contact Gaggenau Customer Support at 1-877-442-4436 to schedule a repair.

24.7 Product information

For handy reference, copy the information below from the rating plate. Keep your invoice and/or delivery documents for warranty validation.

Model number (E-Nr.)

Production number (FD)

Date of delivery

The difference is Gaggenau

gaggenau.com

BSH Home Appliances Corporation

1901 Main Street, Suite 600

Irvine, CA 92614

USA

www.gaggenau.com

1-877-442-4436

© 2026 BSH Home Appliances Corporation



9001954638 (060401)

en-us