

# USER GUIDE

## Parts

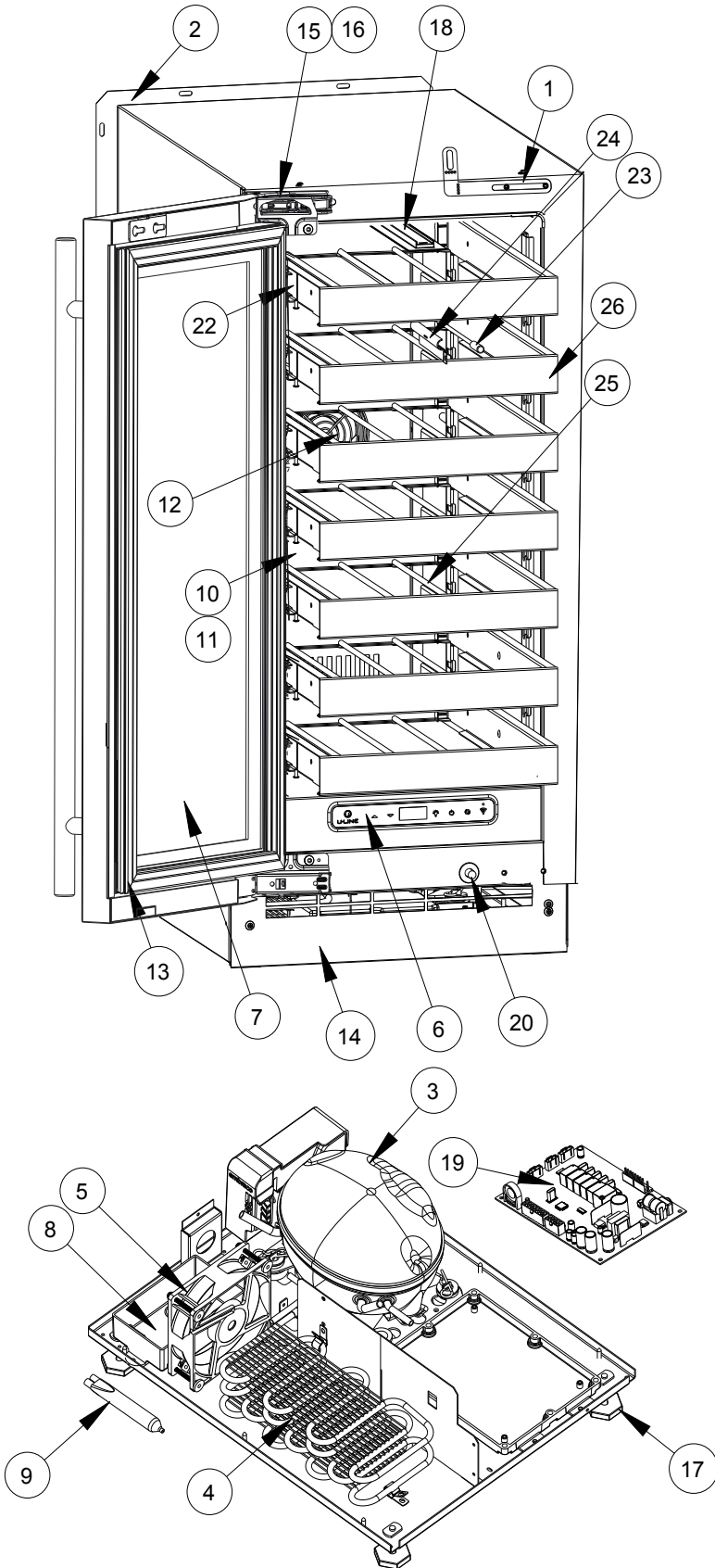

<b>UHWC515-SG51A</b>		
1	ANTI-TIP BRACKET	80-55449-00
2	BACK PANEL	80-55450-00
3	COMPRESSOR W/ELECTRICALS	80-55452-00
4	CONDENSER ASSEMBLY	80-55453-00
5	CONDENSER FAN MOTOR	80-54014-00
6	DISPLAY MODULE	80-55429-00
7	DOOR ASSEMBLY	80-55470-00
8	DRAIN PAN	80-54217-00
9	DRIER	80-54055-00
10	EVAPORATOR ASSEMBLY	80-55458-00
11	EVAPORATOR COVER	80-55456-00
12	EVAPORATOR FAN W/COVER	80-55457-00
13	GASKET, DOOR	80-55459-00
14	GRILLE	80-55461-00
15	HINGE ASSEMBLY	80-55374-00
16	HINGE COVER (2)	80-54001-00
17	LEG LEVELERS (4)	80-54019-00
18	LED LIGHT, 2 COLOR	80-55272-00
19	MAIN BOARD	80-55398-00
20	PLUNGER SWITCH	80-55375-00
21	POWER CORD*	80-55462-00
22	SLIDE ASSEMBLY	80-55509-00
23	THERMISTOR	80-54006-00
24	THERMISTOR COVER	80-55464-00
25	WINE RACK	80-55465-00
26	WINE RACK FRONT	80-55500-00
27	WIRE HARNESS, BOARD*	80-55466-00

\*Not Shown