

Installation Instructions

Over The Range Microwave Oven

BEFORE YOU BEGIN (Read these instructions completely and carefully.)

IMPORTANT

Save these instructions for local inspector's use.

IMPORTANT

Observe all governing codes and ordinances.

- **Note to Installer** - Be sure to leave these instructions with the Consumer.
- **Note to Consumer** - Keep these instructions for future reference.
- **Skill level** - Installation of this appliance requires basic mechanical and electrical skills.
- **Proper installation is the responsibility of the installer.**
- **Product failure due to improper installation is not covered under the Warranty.**

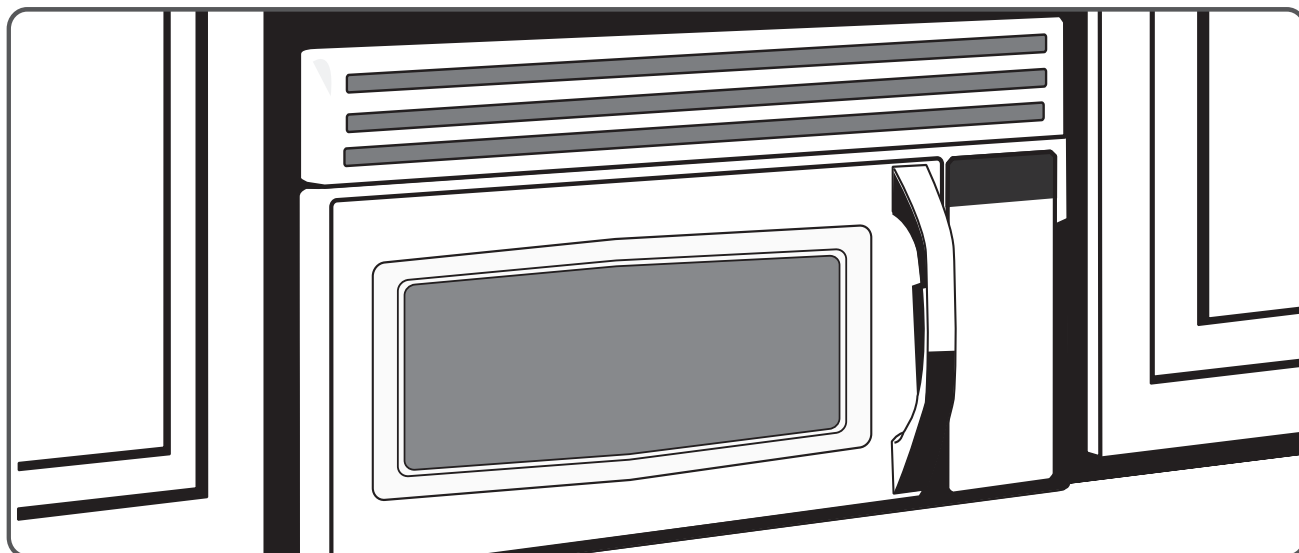

READ CAREFULLY. KEEP THESE INSTRUCTIONS.

Contents

General information

Important safety instructions	3
Electrical requirements	3
Hood exhaust	4
Damage - Shipment/Installation	6
Parts included	6
Tools you will need	7
Mounting space	7

Step-by-step installation guide

1. Placement of the mounting plate	8
A. Removing the microwave oven from the carton/removing the mounting plate	8
B. Finding the wall studs	8
C. Determining wall plate location under your cabinet	9
D. Aligning the wall plate	10
2. Ventilation types (choose a, b or c)	11
A. Outside top exhaust (vertical duct)	12
A1. Installation procedure for exhaust adaptor and proper damper operation check	12
A2. Adjust the exhaust adaptor	12
B. Recirculating (non-vented ductless)	12
B1. Adapting microwave blower for recirculation	12
B2. Installing the charcoal filter	13
C. Outside back exhaust (horizontal duct)	14
C1. Adapting microwave blower for outside back exhaust	14
3. Installation	15
A. Preparing the rear wall for outside back exhaust	15
B. Attach the mounting plate to the wall	15
C. Use top cabinet template for preparation of top cabinet	16
D. Mount the microwave oven	16
E. Connecting ductwork for outside top exhaust	17
Before you use your microwave	18

IMPORTANT SAFETY INSTRUCTIONS

This product requires a three-prong grounded outlet. The installer must perform a ground continuity check on the power outlet box before beginning the installation to insure that the outlet box is properly grounded. If not properly grounded, or if the outlet box does not meet electrical requirements noted (under ELECTRICAL REQUIREMENTS), a qualified electrician should be employed to correct any deficiencies.

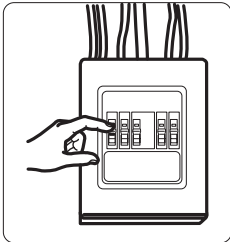

CAUTION: For personal safety, remove house fuse or open circuit breaker before beginning installation to avoid severe or fatal shock injury.

CAUTION: For personal safety, the mounting surface must be capable of supporting the cabinet load, in addition to the added weight of this 59 pound product, plus additional oven loads of up to 50 pounds or a total weight of 109 pounds.

CAUTION: For personal safety, this product cannot be installed in cabinet arrangements such as an island or a peninsula. It must be mounted to BOTH a top cabinet AND a wall.

NOTE: For easier installation and personal safety, it is recommended that two people install this product.

IMPORTANT—PLEASE READ CAREFULLY. FOR PERSONAL SAFETY, THIS APPLIANCE MUST BE PROPERLY GROUNDED TO AVOID SEVERE OR FATAL SHOCK.

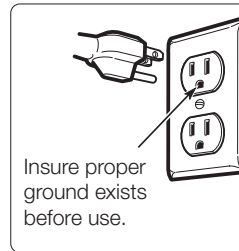

The power cord of this appliance is equipped with a three-prong (grounding) plug which mates with a standard three-prong (grounding) wall receptacle to minimize the possibility of electric shock hazard from this appliance.

You should have the wall receptacle and circuit checked by a qualified electrician to make sure the receptacle is properly grounded.

Where a standard two-prong wall receptacle is encountered, it is very important to have it replaced with a properly grounded three-prong wall receptacle, installed by a qualified electrician.

DO NOT, UNDER ANY CIRCUMSTANCES, CUT, DEFORM OR REMOVE ANY OF THE PRONGS FROM THE POWER CORD. DO NOT USE WITH AN EXTENSION CORD.

ELECTRICAL REQUIREMENTS

Product rating is 120 volts AC, 60 Hertz. This product must be connected to a supply circuit of the proper voltage and frequency. Wire size must conform to the requirements of the National Electrical Code or the prevailing local code for this kilowatt rating. The power supply cord and plug should be brought to a separate branch circuit single grounded outlet of at least 15 A and max of 20 A. 20 A is recommended for multifamily buildings. The outlet box should be located in the cabinet above the microwave oven. The outlet box and supply circuit should be installed by a qualified electrician and conform to the National Electrical Code or the prevailing local code.

General information



HOOD EXHAUST

NOTE: Read these next two pages only if you plan to vent your exhaust to the outside. If you plan to recirculate the air back into the room, proceed to page 11.

OUTSIDE TOP EXHAUST (EXAMPLE ONLY)

The following chart contains an example of one possible ductwork installation.





DUCT PIECES		EQUIVALENT LENGTH	x	NUMBER USED	=	EQUIVALENT LENGTH	
	Roof Cap	24 ft.	x	(1)	=	24 ft.	
	12 Ft. Straight Duct (6" Round)	12 ft.	x	(1)	=	12 ft.	
	Rectangular-to-Round Transition Adaptor*	5 ft.	x	(1)	=	5 ft.	
Equivalent lengths of duct pieces are based on actual tests and reflect requirements for good venting performance with any vent hood.					Total Length	=	41 ft.

* **IMPORTANT:** If a rectangular-to-round transition adaptor is used, the bottom corners of the damper will have to be cut to fit, using the tin snips, in order to allow free movement of the damper.

OUTSIDE BACK EXHAUST (EXAMPLE ONLY)

The following chart contains an example of one possible ductwork installation.



DUCT PIECES		EQUIVALENT LENGTH*	x	NUMBER USED	=	EQUIVALENT LENGTH	
	Wall Cap	40 ft.	x	(1)	=	40 ft.	
	3 Ft. Straight Duct (3 1/4" x 10" Rectangular)	3 ft.	x	(1)	=	3 ft.	
	90 ° Elbow	10 ft.	x	(2)	=	20 ft.	
Equivalent lengths of duct pieces are based on actual tests and reflect requirements for good venting performance with any vent hood.					Total Length	=	63 ft.

NOTE: For back exhaust, care should be taken to align exhaust with space between studs, or wall should be prepared at the time it is constructed by leaving enough space between the wall studs to accommodate exhaust.

NOTE: If you need to install ducts, note that the total duct length of 3 ¼" x 10" rectangular or 6" diameter round duct should not exceed 140 equivalent feet.

Outside ventilation requires a HOOD EXHAUST DUCT. Read the following carefully.

NOTE: It is important that venting be installed using the most direct route and with as few elbows as possible. This ensures clear venting of exhaust and helps prevent blockages. **Also, make sure dampers swing freely and nothing is blocking the ducts.**

Exhaust connection:









The hood exhaust has been designed to mate with a standard 3 ¼" x 10" rectangular duct.

If a round duct is required, a rectangular-to-round transition adaptor must be used. **Do not use less than a 6" diameter duct.**

Maximum duct length:

For satisfactory air movement, the total duct length of 3 ¼" x 10" rectangular or 6" diameter round duct should not exceed 140 equivalent feet.

Elbows, transitions, wall and roof caps, etc., present additional resistance to airflow and are equivalent to a section of straight duct which is longer than their actual physical size. When calculating the total duct length, add the equivalent lengths of all transitions and adaptors plus the length of all straight duct sections. The chart below shows you how to calculate total equivalent ductwork length using the approximate feet of equivalent length of some typical ducts.

DUCT PIECES		EQUIVALENT LENGTH	x	NUMBER USED	=	EQUIVALENT LENGTH
	Rectangular-to-Round Transition Adaptor*	5 ft.	x	()	=	ft.
	Wall Cap	40 ft.	x	()	=	ft.
	90 ° Elbow	10 ft.	x	()	=	ft.
	45 ° Elbow	5 ft.	x	()	=	ft.
	90 ° Elbow	25 ft.	x	()	=	ft.
	45 ° Elbow	5 ft.	x	()	=	ft.
	Roof Cap	24 ft.	x	()	=	ft.
	Straight Duct 6" Round or 3 ¼" x 10" Rectangular	1 ft.	x	()	=	ft.
Total Ductwork					=	ft.



* **IMPORTANT:** If a rectangular-to-round transition adaptor is used, the bottom corners of the damper will have to be cut to fit, using the tin snips, in order to allow free movement of the damper.

Equivalent lengths of duct pieces are based on actual tests and reflect requirements for good venting performance with any vent hood.



General information

DAMAGE - SHIPMENT/INSTALLATION

- **If the unit is damaged in shipment**, return the unit to the store in which it was bought for repair or replacement.
- **If the unit is damaged by the customer**, repair or replacement is the responsibility of the customer.
- **If the unit is damaged by the installer** (if other than the customer), repair or replacement must be made by arrangement between the customer and installer.

PARTS INCLUDED



HARDWARE PACKET

	PART	QUANTITY
	Wood Screws (1/4" x 2")	1
	Toggle Bolts (and wing nuts) (3/16" x 3")	2
	Self-aligning Machine Screws (1/4" - 28 x 3 1/4")	2





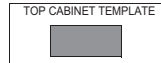
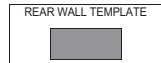

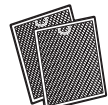
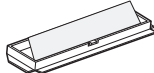







You will find the installation hardware contained in a packet with the unit. Check to make sure you have all these parts.

NOTE: Some extra parts are included.

ADDITIONAL PARTS

	PART	QUANTITY
	Top Cabinet Template	1
	Rear Wall Template	1
	Installation Instructions	1
	Separately Packed Grease Filters	2
	Exhaust adaptor	1

TOOLS YOU WILL NEED

			
#1 and #2 Phillips screwdriver	Pencil	Ruler or tape measure and straight edge	Carpenter square (optional)
			
Tin snips (for cutting damper, if required)	Scissors (to cut template, if necessary)	Electric drill with $\frac{3}{16}$ " $\frac{1}{2}$ " and $\frac{5}{8}$ " drill bits	Filler blocks or scrap wood pieces, if needed for top cabinet spacing (used on recessed bottom cabinet installations only)
			
Gloves	Saw (saber, hole or keyhole)	Stud finder or Hammer (optional)	Safety goggles
			
Level	Duct and masking tape		

MOUNTING SPACE

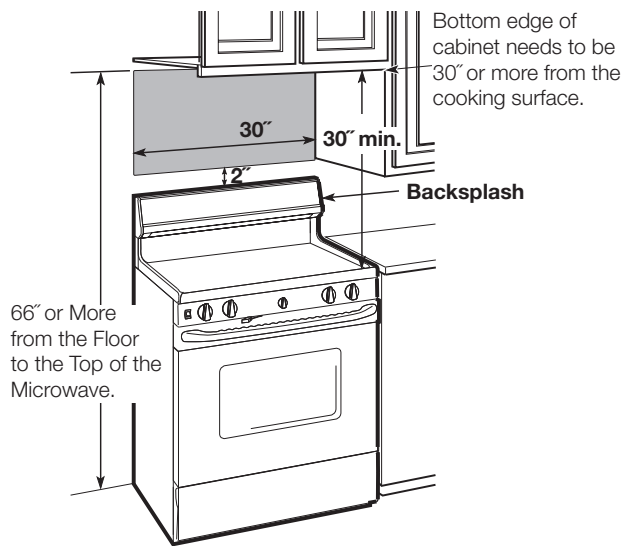

Bottom edge of cabinet needs to be 30" or more from the cooking surface.

30"

30" min.

12"

Backsplash

66" or More from the Floor to the Top of the Microwave.

NOTES:

- The space between the cabinets must be 30" wide and free of obstructions.
- If you are going to vent your microwave oven to the outside, see Hood Exhaust Section for exhaust duct preparation.
- **When installing the microwave oven beneath smooth flat cabinets be careful to follow the instructions on the top cabinet template for power cord clearance.**
- **The dimensions provided are the minimum required for mounting the microwave oven.**
- **Minimum 2" : clearance from the top of the range control panel to the bottom of microwave oven.**

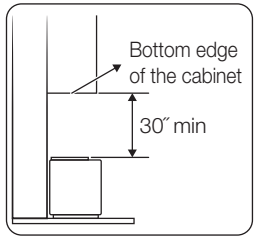

Bottom edge of the cabinet

30" min

ELECTRIC RANGES

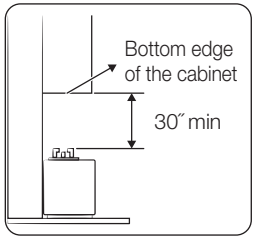

Bottom edge of the cabinet

30" min

GAS RANGES

Step-by-step installation guide

1. PLACEMENT OF THE MOUNTING PLATE

A. REMOVING THE MICROWAVE OVEN FROM THE CARTON/REMOVING THE MOUNTING PLATE

1. Remove the installation instructions, Exhaust adaptor, filters, glass tray and the small hardware bag. Do not remove the Styrofoam protecting the front of the oven.
2. Fold back all 4 carton flaps fully against carton sides. Then carefully roll the oven and carton over onto the top side. The oven should be resting in the Styrofoam.

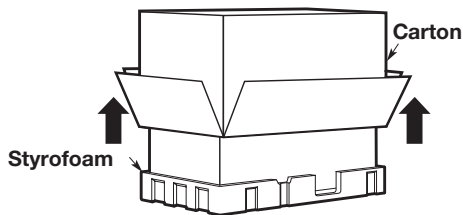

3. Pull the carton up and off the oven.
4. Remove and properly discard plastic bags.

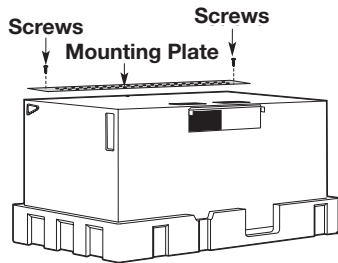

5. Remove the 2 screws from the mounting plate. This plate will be used as the rear wall template and for mounting.

NOTE: You will have to reuse two screws in original location of outcase after removing mounting plate.

B. FINDING THE WALL STUDS

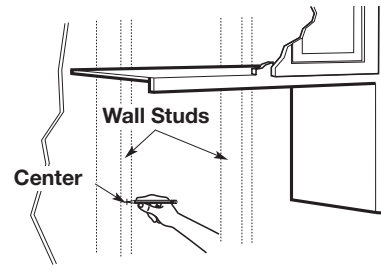

1. Find the studs, using one of the following methods:
 - A. Stud finder—a magnetic device which locates nails.

OR

 - B. Use a hammer to tap lightly across the mounting surface to find a solid sound. This will indicate a stud location.
2. After locating the stud(s), find the center by probing the wall with a small nail to find the edges of the stud. Then place a mark halfway between the edges. The center of any adjacent studs should be 16" or 24" from this mark.
3. Draw a line down the center of the studs.

THE MICROWAVE MUST BE CONNECTED TO AT LEAST ONE WALL STUD.

C. DETERMINING WALL PLATE LOCATION UNDER YOUR CABINET

Plate position – beneath flat bottom cabinet

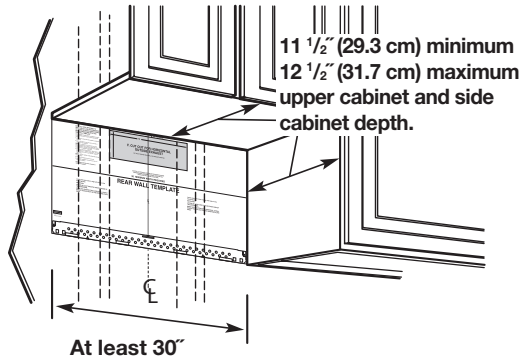

Draw a vertical line on the wall at the center of the 30" wide space.
Tape the Rear Wall Template onto the wall matching the centerline and touching the bottom of the cabinet.

Plate position – beneath recessed bottom cabinet with front overhang

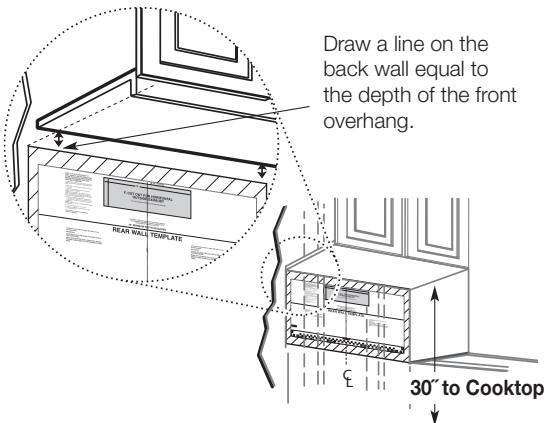

Draw a line on the back wall equal to the depth of the front overhang.

Plate position – beneath framed recessed cabinet bottom

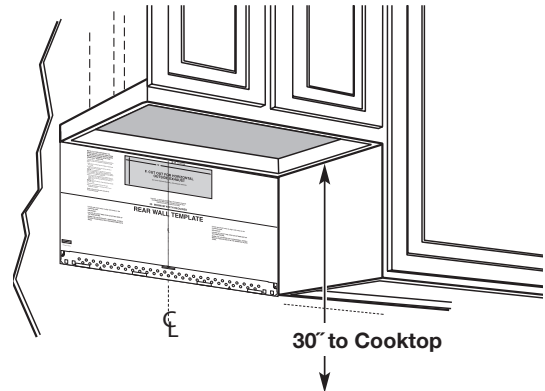

Draw a vertical line on the wall at the center of the 30" space.

Tape the Rear Wall Template onto the wall matching the centerline and touching the bottom cabinet frame.

Your cabinets may have decorative trim that interferes with the microwave installation. Remove the decorative trim to install the microwave properly and to make it level.

THE MICROWAVE MUST BE LEVEL.

Use a level to make sure the cabinet bottom is level. If the cabinets have a front overhang only, with no back or side frame, install the mounting plate down the same distance as the front overhang depth. This will keep the microwave level.

1. Measure the inside depth of the front overhang.
2. Draw a horizontal line on the back wall an equal distance below the cabinet bottom as the inside depth of the front overhang.
3. For this type of installation with front overhang only, align the mounting tabs with this horizontal line, not touching the cabinet bottom as described in Step D.

Step-by-step installation guide

D. ALIGNING THE WALL PLATE

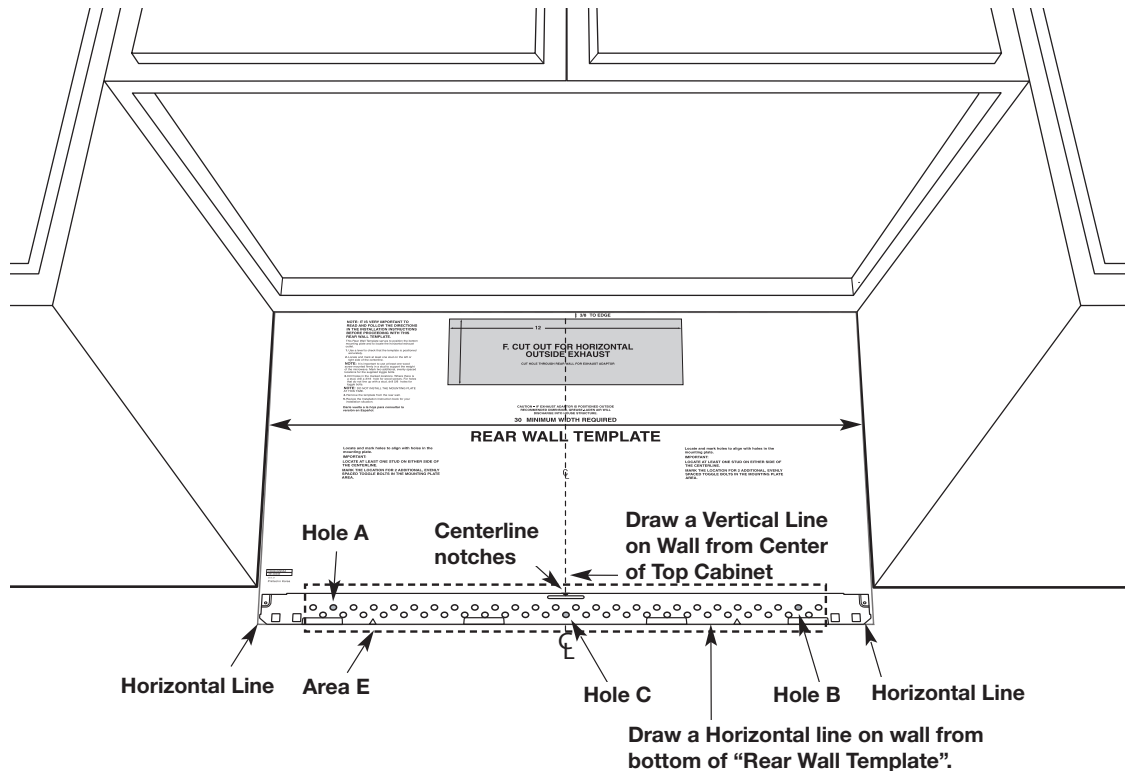

CAUTION: Wear gloves to avoid cutting fingers on sharp edges.

1. Draw a Vertical line on the wall at the center of the 30" wide space.
2. Draw a Horizontal line on the wall at the bottom of "Rear Wall Template".
3. Drill $\frac{5}{8}$ " holes for toggle bolts on 3 locations (Hole A, Hole B, Hole C) but if the location of hole is same as that of stud, drill a $\frac{3}{16}$ " hole for wood screw. In other words, toggle bolt can not be used to the location of stud.

NOTE: DO NOT MOUNT THE PLATE AT THIS TIME.

NOTE: Holes A, B and C are inside area E. If none of A, B and C is in a stud, find a stud somewhere in area E and draw a forth circle to line up with the stud. It is important to use **at least one wood screw** mounted **firmly in a stud** to support the weight of the microwave. **Set the mounting plate aside.**

2. VENTILATION TYPES (CHOOSE A, B OR C)

This microwave oven is designed for adaptation to the following three types of ventilation:

- A. Outside Top Exhaust (Vertical Duct)**
- B. Recirculating (Non-Vented Ductless)**
- C. Outside Back Exhaust (Horizontal Duct)**

NOTE: This microwave is shipped assembled for Outside Top Exhaust (except for non-vented models). And exhaust adaptor is shipped assembled to the filler-upper. Select the type of ventilation required for your installation and proceed to that section.

A. OUTSIDE TOP EXHAUST (VERTICAL DUCT)

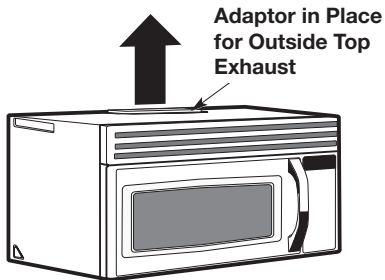

See page 12

B. RECIRCULATING (NON-VENTED DUCTLESS)

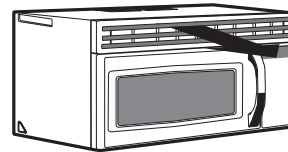

See page 13

A Charcoal Filter Accessory Kit is required for the nonvented exhaust. (See your Owner's Manual for the kit number.)

C. OUTSIDE BACK EXHAUST (HORIZONTAL DUCT)

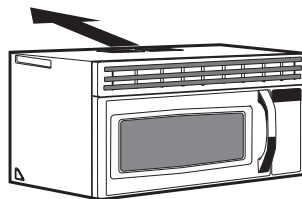

See page 14

Step-by-step installation guide

A. OUTSIDE TOP EXHAUST (VERTICAL DUCT)

A1. INSTALLATION PROCEDURE FOR EXHAUST ADAPTOR AND PROPER DAMPER OPERATION CHECK

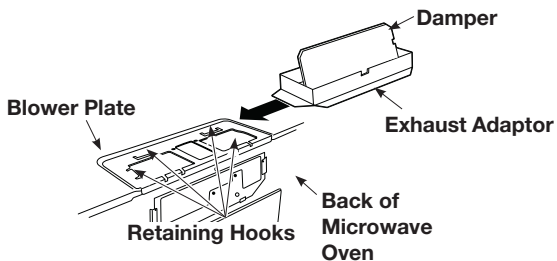

1. Slide exhaust adaptor following the instructions show in diagram.
2. Make sure tape securing damper is removed and damper pivots easily before mounting microwave.

 - You will need to make adjustments to assure proper alignment with your house exhaust duct after the microwave is installed.

A2. ADJUST THE EXHAUST ADAPTOR

Open the top cabinet and adjust the exhaust adaptor to connect to the house duct.

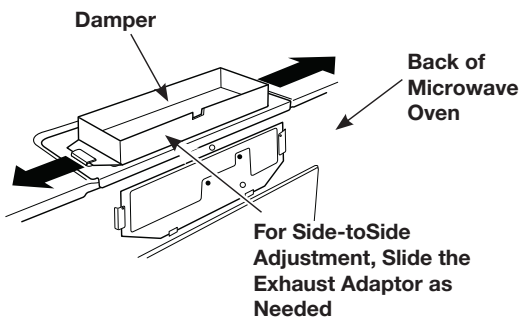

NOTE: The house duct is needed to connect to the exhaust adaptor after installation completion.

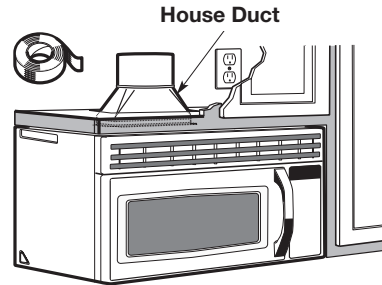

B. RECIRCULATING (NON-VENTED DUCTLESS)

B1. ADAPTING MICROWAVE BLOWER FOR RECIRCULATION

1. Remove and save screw that holds blower plate to microwave.
2. Lift up the blower plate.

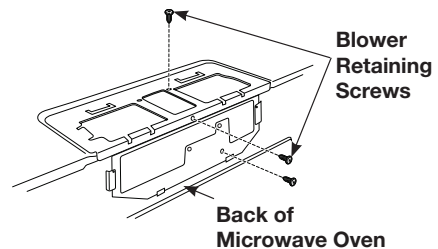

NOTE: The exhaust adaptor with damper is not needed for recirculating models. You may want to save them for possible future use.

3. Remove screw holds blower motor and carefully pull out the blower unit. The wires will extend far enough to allow you to adjust the blower unit.

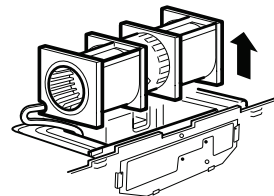

CAUTION: Do not touch blade of blower for preventing crack and break. Hold outer case when the blower pull out or back into.

Step-by-step installation guide

- Roll the blower unit 90° so that fan blade openings are facing toward the front of the microwave.

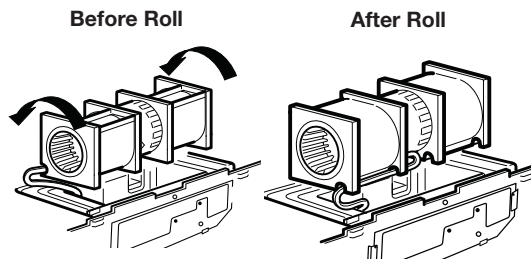

- Place the blower unit back into the opening.

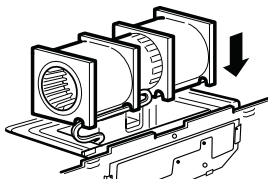

CAUTION: Do not pull or stretch the blower unit wiring. Make sure the wires are not pinched.

- Remove the metal vent fan cover on the back of the microwave by sliding it up.

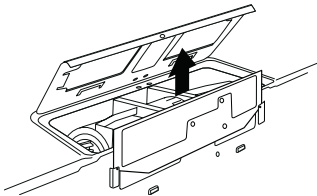

- Close the blower door. Slide blower shield onto the top of the blower door opening.

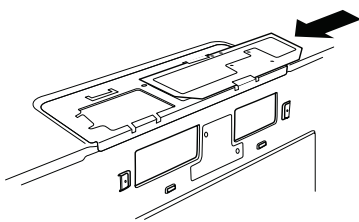

- Secure the blower to the microwave using the blower retaining screws from Step 1.

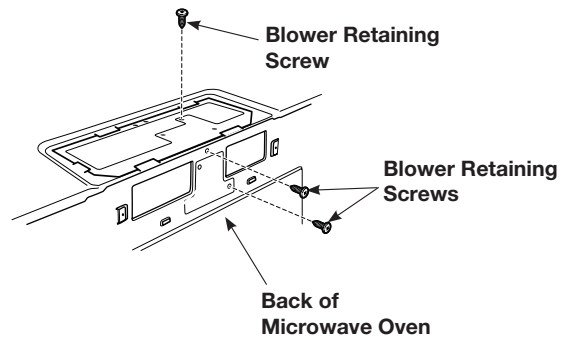

B2. INSTALLING THE CHARCOAL FILTER

- Remove screws on top of grille using a #1 Phillips screwdriver.
- Open the door.
- Remove the grille.
 - After push left, Pull the grille straight off.

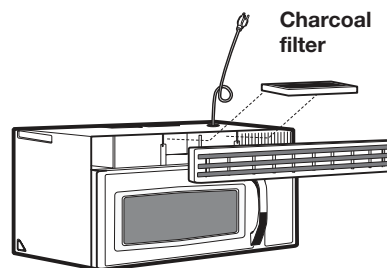

- Install the charcoal filter. When properly installed, the wire mesh of the filter should be visible from the front.
- Reinstall the grille and the screws.
- Close the door.

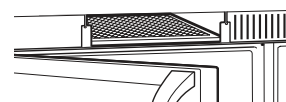

Insert mesh-side up

Step-by-step installation guide

C. OUTSIDE BACK EXHAUST (HORIZONTAL DUCT)

C1. ADAPTING MICROWAVE BLOWER FOR OUTSIDE BACK EXHAUST

1. Remove and save screw that holds blower Plate to microwave.

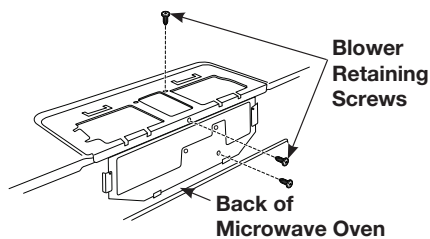

2. Open the blower door by lifting it up at the back of the microwave. Remove and save the blower shield on the back of the microwave by sliding it up. Remove and save the metal vent fan cover on the back of the microwave by sliding it up.

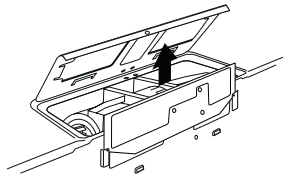

3. Carefully pull out the blower unit. The wires will extend far enough to allow you to adjust the blower unit.

BEFORE: Fan Blade Openings Facing Forward

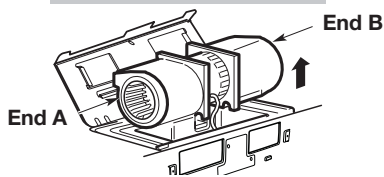

CAUTION: Do not touch blade of blower to prevent cracking and breaking. Hold outer case when the blower is removed and re-installed.

(On Some model)

4. Remove Parts "A" with tin snips or pliers.

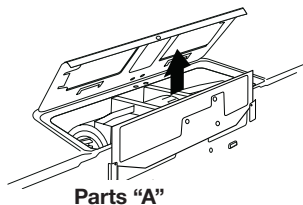

5. Rotate blower unit counterclockwise 180°.

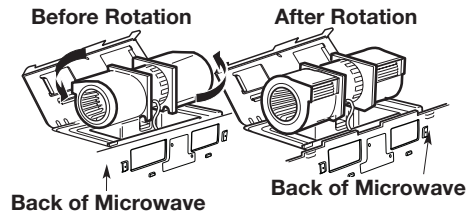

6. Place the blower unit back into the opening.

AFTER: Fan Blade Openings Facing Back

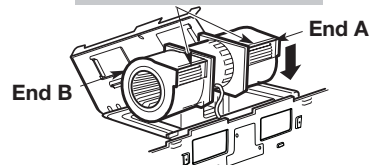

CAUTION: Do not pull or stretch the blower unit wiring. Make sure the wires are not pinched.

NOTE: The blower unit exhaust openings should match exhaust openings on rear of microwave oven.

7. Close the blower door. Slide blower shield onto the top of the blower door opening. Secure the blower to the microwave oven using the blower retaining screws from Step 1 except the upper blower motor retaining screw.

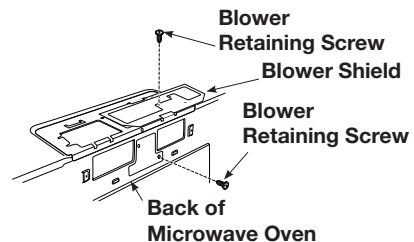

8. Slide the exhaust adaptor onto the back of the microwave oven, securing it into the lower locking tabs. Take care to ensure that the damper hinge is installed so that it is at the top and that the damper swings freely. Reinstall the upper blower motor screw through the adaptor and the blower door and into the back of the microwave oven.

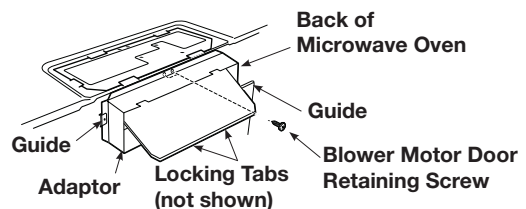

3. INSTALLATION

INSTALLATION OVERVIEW

- A. Prepare Rear Wall (only horizontal duct)
- B. Attach Mounting Plate to Wall
- C. Prepare Top Cabinet
- D. Mount the Microwave Oven
- E. Connecting Ductwork (only vertical duct)

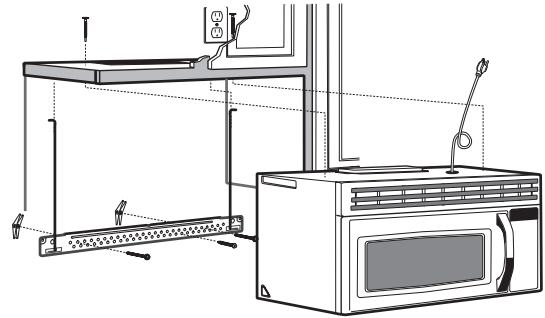

A. PREPARING THE REAR WALL FOR OUTSIDE BACK EXHAUST

You need to cut an opening in the rear wall for outside exhaust.

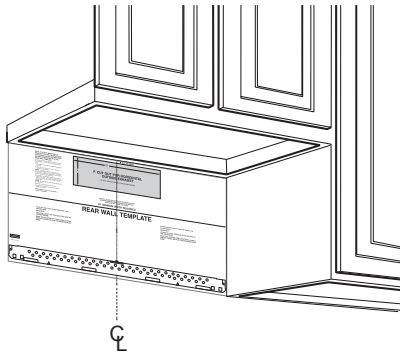

- Read the instructions on the REAR WALL TEMPLATE.
- Tape it to the rear wall.
- Cut the opening, following the instructions of the REAR WALL TEMPLATE.

CAUTION: Do not cut an opening on the real wall, in case of vertical duct and non-vented ductless.

B. ATTACH THE MOUNTING PLATE TO THE WALL

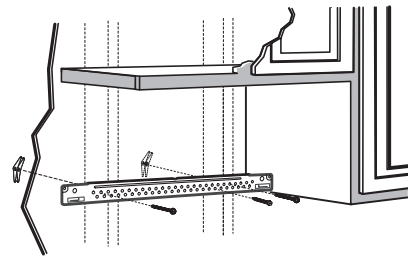

Attach the plate to the wall using toggle bolts. At least one wood screw must be used to attach the plate to a wall stud.

1. Remove the toggle wings from the bolts.
2. Insert the bolts into the mounting plate through the holes designated to go into drywall and reattach the toggle wings to $\frac{3}{4}$ " onto each bolt.

Step-by-step installation guide

To use toggle bolts:

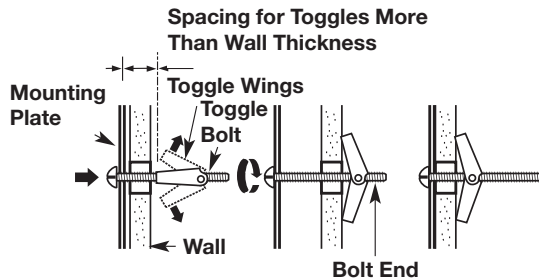

3. Place the mounting plate against the wall and insert the toggle wings into the holes in the wall to mount the plate.

NOTE: Before tightening toggle bolts and wood screw, make sure to coincide bottom line of the Mounting plate with Horizontal line of “Rear wall Template” and then the Mounting plate is properly centered under the cabinet.

CAUTION: Be careful to avoid pinching fingers between the back of the mounting plate and the wall.

4. Tighten all bolts. Pull the plate away from the wall to help tighten the bolts.

C. USE TOP CABINET TEMPLATE FOR PREPARATION OF TOP CABINET

You need to drill holes for the top support screws and a hole large enough for the power cord to fit through.

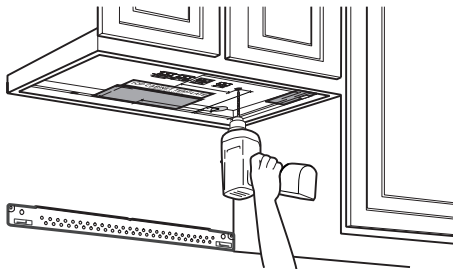

- Read the instructions on the TOP CABINET TEMPLATE.
- Tape it underneath the top cabinet.
- Drill the holes, following the instructions on the TOP CABINET TEMPLATE.

CAUTION: Wear safety goggles when drilling holes in the cabinet bottom.

D. MOUNT THE MICROWAVE OVEN

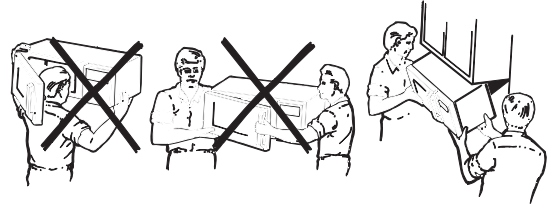

FOR EASIER INSTALLATION AND PERSONAL SAFETY, WE RECOMMEND THAT TWO PEOPLE INSTALL THIS MICROWAVE OVEN.

IMPORTANT: Do not grip or use handle during installation.

NOTE: If your cabinet is metal, use the nylon grommet around the power cord hole to prevent cutting of the cord.

NOTE: Filler blocks are required when mounting this unit under any cabinet with a recessed bottom or front overhang. (See page 9.)

IMPORTANT: The case damage that will occur from over tightening screws when filler blocks are not used is not covered under warranty.

NOTE: When mounting the microwave oven, thread power cord through hole in bottom of top cabinet. Keep it tight throughout Steps 1–3. Do not pinch cord or lift oven by pulling cord.

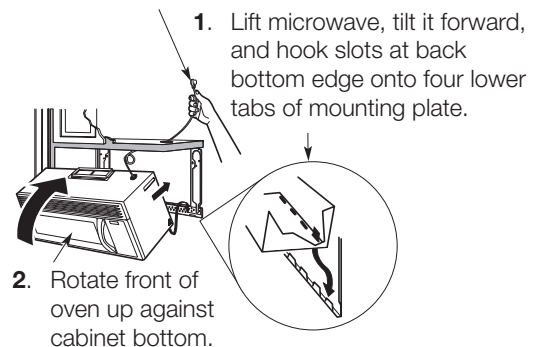

3. Insert a self-aligning screw through top center cabinet hole. Temporarily secure the oven by turning the screw at least **two full turns** after the threads have engaged. (It will be completely tightened later.) **Be sure to keep power cord tight. Be careful not to pinch the cord, especially when mounting flush to bottom of cabinet.**

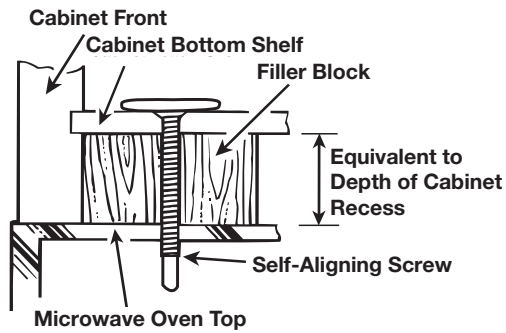

4. Attach the microwave oven to the top cabinet.
5. Insert the 2 self-aligning screws through the cabinet bottom shelf and filler block into the outer top cabinet of the unit. Continue to support the unit until both screws are inserted and engaged at least two full turns, then fully tighten both screws until the unit is secure.

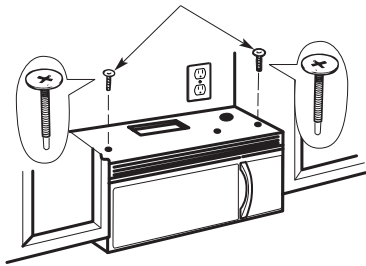

6. Install grease filters. See the Owner's Manual packed with the microwave.

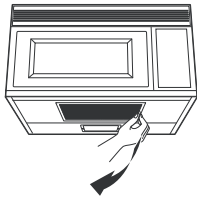

E. CONNECTING DUCTWORK FOR OUTSIDE TOP EXHAUST

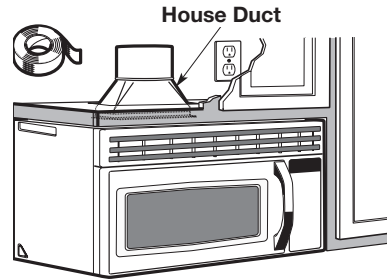

1. Extend the house duct down to connect to the exhaust adaptor.
2. Seal exhaust duct joints using duct tape.

Before You Use Your Microwave

BEFORE YOU USE YOUR MICROWAVE

1. Make sure the microwave oven has been installed according to instructions.



-
2. Remove all packing material from the microwave oven.

-
3. Install turntable and ring in cavity.

-
4. Replace house fuse or turn breaker back on.

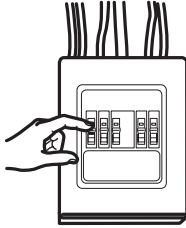

-
5. Plug power cord into a dedicated 15 amp electrical outlet.

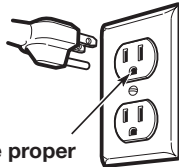

Insure proper ground exists before use

6. Read the Owner's Manual.



-
7. Keep installation instructions for the local inspector's use.



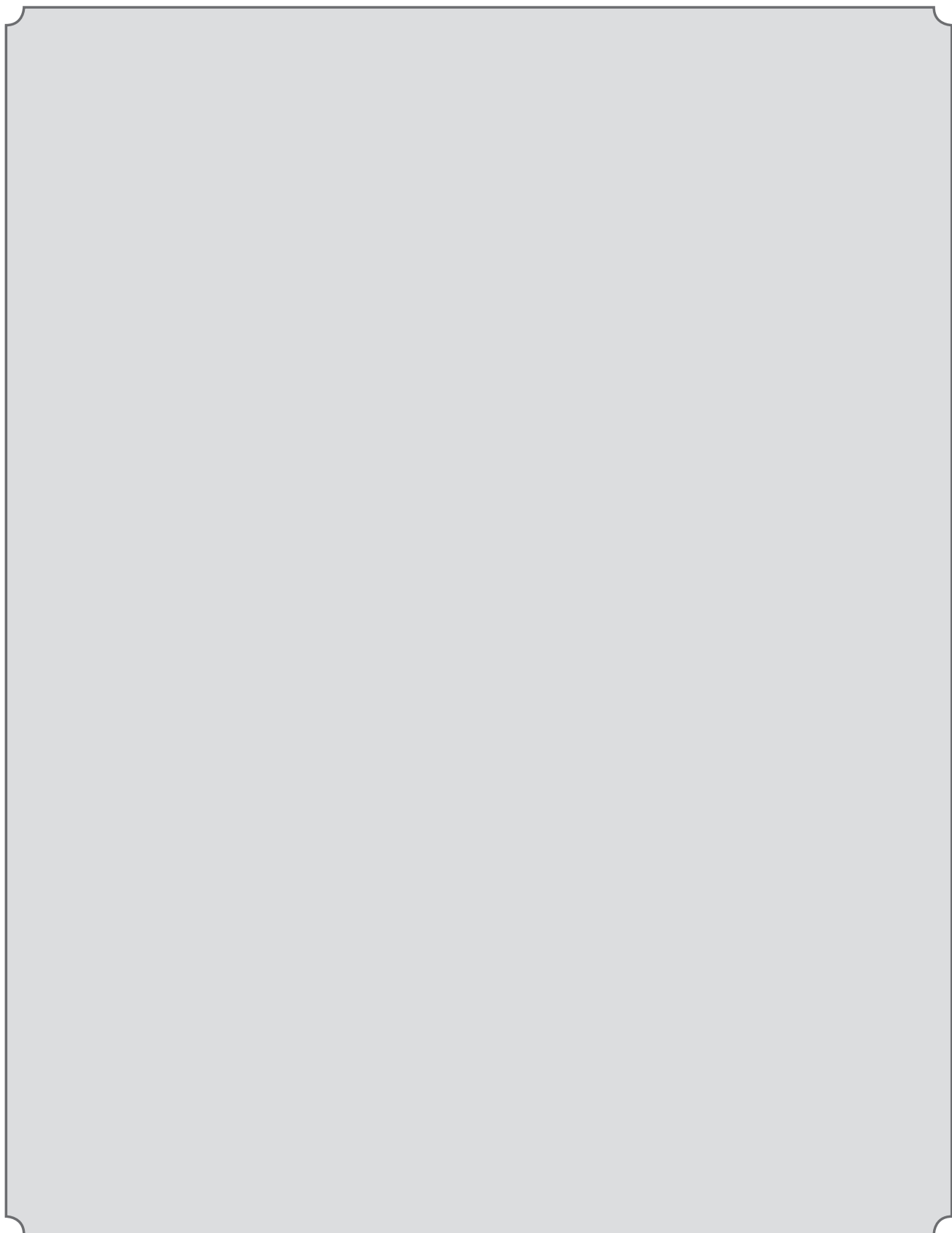

SAMSUNG



DE68-04584A-03