

# Warming drawer

GW083790



You can find additional information and explanations online.  
Scan the QR code on the title page.



# Table of contents

<b>1</b>	<b>IMPORTANT SAFETY INSTRUCTIONS</b>	<b>3</b>	12.3	Ending the "Low-temperature cooking" function	11
1.1	Safety definitions	3	<b>13</b>	<b>Additional applications</b>	<b>11</b>
1.2	IMPORTANT SAFEGUARDS	3	<b>14</b>	<b>Defrosting</b>	<b>11</b>
1.3	Safe use	3	14.1	Defrosting food	11
1.4	Child safety	4	<b>15</b>	<b>How it works</b>	<b>12</b>
1.5	Food safety	4	15.1	Recommended settings for keeping food warm	12
1.6	Proper installation and maintenance	4	15.2	Recommended settings for low-temperature cooking	12
1.7	Remote operation	5	15.3	Recommended settings for other applications	13
1.8	State of California Proposition 65 Warnings	5	15.4	Recommended settings for defrosting	13
<b>2</b>	<b>Preventing material damage</b>	<b>6</b>	<b>16</b>	<b>Home Connect®</b>	<b>14</b>
<b>3</b>	<b>Environmental protection and energy-saving</b>	<b>6</b>	16.1	Setting up Home Connect®	14
3.1	Disposal of packaging	6	16.2	Resetting the Wi-Fi settings and switching off the Wi-Fi	14
3.2	Saving energy	6	16.3	Software update	14
<b>4</b>	<b>Familiarizing yourself with your appliance</b>	<b>6</b>	16.4	Data Protection	14
4.1	Appliance	6	<b>17</b>	<b>Cleaning and maintenance</b>	<b>15</b>
4.2	Control panel	7	17.1	Cleaning agents	15
4.3	Sabbath mode	8	17.2	Cleaning the appliance	15
4.4	Lighting	8	17.3	Cleaning the stainless steel surfaces	15
4.5	Safety shut-off	8	17.4	Cleaning the glass plate	15
<b>5</b>	<b>Accessories</b>	<b>8</b>	<b>18</b>	<b>Troubleshooting</b>	<b>15</b>
<b>6</b>	<b>Before using for the first time</b>	<b>8</b>	18.1	Malfunctions	15
6.1	Cleaning and heating up the appliance before using it for the first time	8	18.2	Demo mode	16
<b>7</b>	<b>Cookware</b>	<b>8</b>	<b>19</b>	<b>Information regarding Free and Open Source Software</b>	<b>16</b>
7.1	Cookware for appliances with a height of 8½" (21.5 cm)	8	<b>20</b>	<b>Customer Service</b>	<b>17</b>
<b>8</b>	<b>Basic Operation</b>	<b>9</b>	20.1	Model number (E-Nr.), production number (FD) and consecutive numbering (Z-Nr.)	17
8.1	Opening the appliance	9	20.2	Rating plate location	17
8.2	Closing the appliance	9	<b>21</b>	<b>Disposal</b>	<b>17</b>
8.3	Switching on the appliance	9	21.1	Disposal of your old appliance	17
8.4	Switching off the appliance	9	<b>22</b>	<b>STATEMENT OF LIMITED PRODUCT WARRANTY</b>	<b>17</b>
8.5	Setting the temperature	9	22.1	What this warranty covers & Who it applies to	17
8.6	Adjusting the default temperature	9	22.2	How long the warranty lasts	18
8.7	Starting the "Sabbath mode" function	9	22.3	Repair/replace as your exclusive remedy	18
8.8	Ending the "Sabbath mode" function	9	22.4	Out of warranty product	18
<b>9</b>	<b>Preheating tableware</b>	<b>9</b>	22.5	Warranty exclusions	18
9.1	Starting the "Preheat tableware" function	9	22.6	Obtaining warranty service	19
9.2	Ending the "Preheat tableware" function	10	22.7	Product information	19
<b>10</b>	<b>Preheating cups</b>	<b>10</b>			
10.1	Starting the "Preheat cups" function	10			
10.2	Ending the "Preheat cups" function	10			
<b>11</b>	<b>Keeping food warm</b>	<b>10</b>			
11.1	Starting the "Keep food warm" function	10			
11.2	Ending the "Keep food warm" function	10			
<b>12</b>	<b>Low-temperature cooking</b>	<b>10</b>			
12.1	Tips for low-temperature cooking	11			
12.2	Starting the "Low-temperature cooking" function	11			



# IMPORTANT SAFETY INSTRUCTIONS

## READ AND SAVE THESE INSTRUCTIONS

Read all of the instructions carefully before using the appliance. In order to reduce the risk of fire, electric shocks and personal injuries when using the appliance, follow the basic safety precautions, including the following safety instructions.

### 1.1 Safety definitions

Here you can find explanations of the safety signal words used in this manual.

#### **WARNING**

This indicates that death or serious injuries may occur as a result of non-observance of this warning.

#### **CAUTION**

This indicates that minor or moderate injuries may occur as a result of non-observance of this warning.

#### **NOTICE**

This indicates that damage to the appliance or property may occur as a result of non-compliance with this advisory.

**Note:** This alerts you to important information.

### 1.2 IMPORTANT SAFEGUARDS

#### **WARNING**

When using electrical appliances, basic safety precautions should always be followed including the following:

- ▶ Read all instructions.
- ▶ Do not touch hot surfaces. Use the touch keys on the control panel.
- ▶ To protect against electrical shock do not immerse the power cord or plugs in water or other liquids.
- ▶ Close supervision is necessary when any appliance is used by or near children.
- ▶ Allow to cool before putting on or taking off parts.
- ▶ Do not operate any appliance with a damaged cord or plug, or after the appliance malfunctions or has been damaged in any manner. Return the appliance to the nearest authorized service provider for examination, repair, or adjustment.
- ▶ Do not use the appliance outdoors.
- ▶ Do not let the power cord touch hot surfaces.
- ▶ Extreme caution must be used when opening the drawer if it contains a receptacle with hot liquids.
- ▶ Always attach the plug to appliance first, then plug the power cord into the wall outlet. To disconnect, turn any control to "off", then remove the plug from wall outlet.
- ▶ Do not use the appliance for other than its intended use.
- ▶ Save these instructions.

### 1.3 Safe use

#### **WARNING**

When properly cared for, your new appliance has been designed to be safe and reliable.

- ▶ Read all instructions carefully before use. These precautions will reduce the risk of burns, electric shock, fire, and injury to persons.
- ▶ When using kitchen appliances, basic safety precautions must be followed, including those in the following pages.

This appliance is intended for normal family household use only. It is not approved for outdoor use. See the Statement of Limited Product Warranty. If you have any questions, contact the manufacturer.

Examine the appliance after unpacking it. In the event of transport damage, do not plug it in.

#### **WARNING**

Do not touch the interior surfaces of the drawer while it is in use. The interior of the drawer could become hot enough to cause burns.

- ▶ Allow drawer and rack (if equipped) to cool before handling.

#### **WARNING**

Storage in or on Appliance - The use of corrosive chemicals in heating or cleaning will damage the appliance and could result in injury.

- ▶ Flammable materials, corrosive chemicals, vapors or non-food products should not be stored or used in an oven or on or near surface units.
- ▶ The appliance is specifically designed for use when heating or cooking food.

#### **WARNING**

If materials inside an oven or warming drawer should ignite, keep door closed.

- ▶ Turn off the appliance and disconnect the circuit at the circuit breaker box.

#### **WARNING**

Using this appliance other than for its intended use can cause fire or injury to persons.

- ▶ Use this appliance only for its intended use as described in this manual.
- ▶ NEVER use your appliances as a space heater for warming or heating the room. Doing so may result in overheating the appliance.
- ▶ Never use the appliance for storage.

#### **WARNING**

A fire could occur during cooking.

- ▶ Always have a working smoke detector near the kitchen.
- ▶ Have an appropriate fire extinguisher available, nearby, highly visible and easily accessible near the appliance.

In the event that personal clothing or hair catches fire, drop and roll immediately to extinguish flames.

Do Not Use Water on Grease Fires.

- ▶ Smother fire or flame or use dry chemical or foam-type extinguisher.



# IMPORTANT SAFETY INSTRUCTIONS

## READ AND SAVE THESE INSTRUCTIONS

### WARNING

Do not heat or warm unopened food containers. Build-up of pressure may cause the container to burst and cause injury.

### WARNING

Use Only Dry Potholders - Moist or damp potholders on hot surfaces may result in burns from steam.

- ▶ Do not let potholders touch hot heating elements.
- ▶ Do not use a towel or other bulky cloth.

To prevent burns, do not remove the drawer while it is hot. Be sure the drawer is empty before removing it.

### WARNING

Wear Proper Apparel.

Loose-fitting or hanging garments, such as ties, scarves, jewelry, or dangling sleeves, should never be worn while using the appliance.

- ▶ Tie long hair so that it does not hang loose.
- ▶ Secure all loose garments, etc. before beginning.

### NOTICE

Plastic containers or plastic wrap can melt if they come in direct contact with the drawer or a hot utensil. If it melts onto the drawer, it may not be removable.

### WARNING

The light emitted by LED lights is very dazzling, and can damage the eyes.

- ▶ Do not look directly into the switched-on LED lights for longer than 100 seconds.

### WARNING

While cooking food items, small amounts of certain by-products, such as particulate matter / soot, can be released. To minimize exposure to these substances:

- ▶ Always ensure proper ventilation by using an appropriate ventilation fan or hood vented to the outside and/or an open window.
- ▶ Always operate the unit according to the instructions in this manual.

### WARNING

Overheated materials can cause fire or burns and may produce potentially harmful smoke or fumes.

- ▶ To prevent overheating, turn ventilation hood ON when heating grease, fats or frying using medium to high heat settings.
- ▶ Avoid heating empty pots and pans.
- ▶ Do not allow pans to boil dry.
- ▶ Do not allow aluminum foil, plastic, paper, or cloth to come in contact with a hot surface element, burner, or grate.

## 1.4 Child safety

This appliance is not intended for use by persons (including children) with reduced physical, sensory or mental capabilities, or lack of experience and knowledge, unless they have been given supervision or instruction concerning use of the appliance by a person responsible for their safety.

When children become old enough to use the appliance, it is the responsibility of the parents or legal

guardians to ensure that they are instructed in safe practices by qualified persons. Children should be supervised to ensure that they do not play with the appliance.

### WARNING

Do not allow children to use this appliance unless closely supervised by an adult.

- ▶ Children and pets should not be left alone or unattended in the area where the appliance is in use. They should never be allowed to play in its vicinity, whether or not the appliance is in use.

Do not allow anyone to climb, stand, lean, sit, or hang on any part of an appliance, especially a door, warming drawer, or storage drawer.

- ▶ This can damage the appliance, and the unit may tip over, potentially causing severe injury.

Do not let children play with the appliance.

### CAUTION

Do not store items of interest to children in an appliance, in cabinets above an appliance or on the back-guard of an appliance.

Children climbing on the appliance to reach items could be seriously injured.

Do Not Leave Children Alone.

- ▶ Children should not be left alone or unattended in the area where the appliance is in use.
- ▶ They should never be allowed to sit or stand on any part of the appliance.

### WARNING

To avoid the risk of suffocation:

- ▶ Do not allow children to play with packaging material.

## 1.5 Food safety

### CAUTION

To maintain food safety, follow these guidelines

- ▶ DO NOT use a warming drawer to heat cold food. It is safe to use the drawer to crisp crackers, chips or dry cereal and to warm plates.
- ▶ Be sure to maintain proper food temperature. The USDA recommends holding hot food at 140°F or warmer.
- ▶ DO NOT leave food in the warming drawer for more than one hour before or after cooking.
- ▶ Plastic containers, plastic wrap or aluminum foil can melt if in direct contact with the drawer or a hot cooking container. If it melts onto the drawer, it may not be removable.

## 1.6 Proper installation and maintenance

### WARNING

In the event of a malfunction, it might become necessary to turn off the power supply.

- ▶ Have the installer show you the circuit breaker or fuse. Mark it for easy reference.

To avoid electrical shock hazard, before servicing the appliance, turn power off at the service panel and lock



# IMPORTANT SAFETY INSTRUCTIONS

## READ AND SAVE THESE INSTRUCTIONS

---

the panel to prevent the power from being switched on accidentally.

Proper Installation - Improper installation or grounding can cause electric shock.

- ▶ This appliance must be properly installed and grounded by a qualified technician.
- ▶ Connect only to properly grounded outlet.
- ▶ Refer to installation instructions for details.

User Servicing - Do not repair or replace any part of the appliance unless specifically recommended in this manual.

- ▶ All other servicing should be referred to an authorized service provider.

### WARNING

Malfunctions can cause injuries.

- ▶ Do not operate this appliance if it is not working properly, or if it has been damaged. Contact an authorized service provider.

## 1.7 Remote operation

### CAUTION

This appliance may be configurable to allow remote operation at any time.

- ▶ Do not store any flammable materials or temperature sensitive items inside, on top or near surface units of the appliance.

## 1.8 State of California Proposition 65

### Warnings

This product may contain a chemical known to the State of California, which can cause cancer or reproductive harm. Therefore, the packaging of your product may bear the following label as required by California:

**STATE OF CALIFORNIA PROPOSITION 65 WARNING:**



**WARNING**

Cancer and Reproductive Harm - [www.P65Warnings.ca.gov](http://www.P65Warnings.ca.gov)

## 2 Preventing material damage

### NOTICE

Excessive weight may damage the appliance.

- ▶ The appliance has a maximum load capacity of 55 lbs (25 kg).

Moisture may damage the appliance.

- ▶ Do not use the appliance to store food and drinks. The moisture in the food may cause corrosion damage.

Carrying the appliance by the appliance frame may cause it to bend. The appliance frame cannot support

the weight of the appliance.

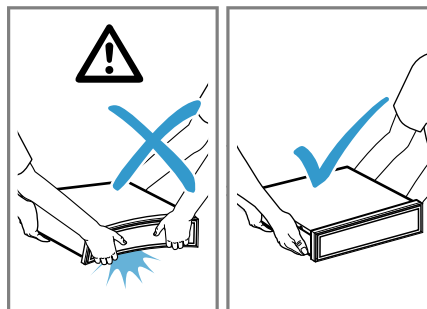

- ▶ Do not lift the appliance using the appliance frame.
- ▶ Always lift the appliance at the casing.

## 3 Environmental protection and energy-saving

### 3.1 Disposal of packaging

The packaging materials are environmentally compatible and can be recycled.

- ▶ Sort the individual components by type and dispose of them separately.

### 3.2 Saving energy

If you follow these instructions, your appliance will use less power.

To preheat tableware efficiently, distribute the tableware evenly throughout the appliance.

It is more energy-efficient to prepare food, e.g. low-temperature cooking, in the warming drawer rather than in the oven.

## 4 Familiarizing yourself with your appliance

This Use and Care Manual covers several models. Your model may have some but not all of the features listed.

### 4.1 Appliance

Here you can find an overview of the parts of your appliance.

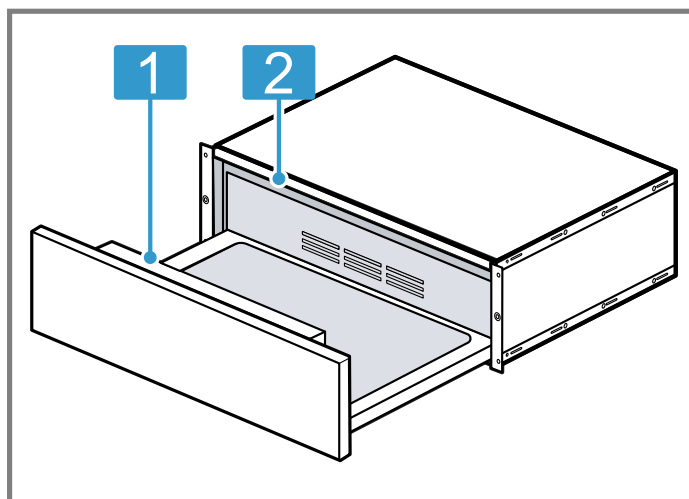

1 Control panel

2 Lighting

## 4.2 Control panel

You can use the control panel to configure all functions of your appliance and to obtain information about the operating status.

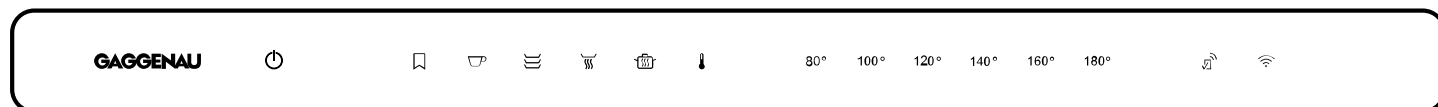

### Touch fields

Touch fields are touch-sensitive surfaces. To select a function, press the relevant field.

Touch field	Function
	Switching the appliance on or off
	Adding favorites <sup>1</sup>
	Preheating cups
	Preheating tableware
	Keeping food warm
	Low-temperature cooking
	Setting the temperature
80° - 180°	Selecting a temperature <sup>2</sup>
	Starting Home Connect® pairing

### Notes

- If you touch the touch field, the appliance performs the corresponding function.
- Touch fields that cannot currently be selected do not light up.
- The settings that are currently selected light up in color.
- Always keep the controls dry. Moisture reduces their effectiveness.

### Displays

The displays on the control panel show the operating status of the appliance.

Display	Function
lights up white	Home Connect® is available.
flashes white	Appliance connects to Home Connect®.
lights up in color	Appliance is connected to Home Connect®.
flashes in color	Connection to Home Connect® is faulty.

The operation indicator is located on the appliance's front panel.

Operation indicator	Function
Off	Appliance OFF





<sup>1</sup> Only available if the appliance is connected to Home Connect®.

<sup>2</sup> Depending on the selected operating mode.

## Default temperature and temperature range

The appliance displays the possible temperature range depending on the operating mode selected. The selected operating mode and the corresponding default temperature light up in color.

When the appliance is switched on, the operating mode and temperature that were last set light up in color.

Operating mode	Default temperature in °F (°C)	Adjustable temperature range in °F (°C)
Preheat cups 	120 (50)	100 - 140 (40 - 60)
Preheat cookware 	140 (60)	120 - 160 (50 - 70)
Keep food warm 	160 (70)	140 - 180 (60 - 80)
Low-temperature cooking 	180 (80)	160 - 180 (70 - 80)
Temperature range 	120 (50)	80 - 180 (30 - 80)

### 4.3 Sabbath mode

Your appliance maintains the temperature of your food between 80 and 180°F (30 and 80°C) over a longer period of time.

You can keep food warm for up to 74 hours without having to switch the appliance on or off. Bear in mind that food which spoils easily should not be left in the appliance for too long.

If you open the appliance for this function, the appliance continues to heat up and the fan runs.

With "Sabbath mode" the interior light remains always off.

### 4.4 Lighting

By default, the lighting switches on automatically when the appliance is opened.

You can switch the lighting on and off, and change the factory setting, using the Home Connect® app.

### 4.5 Safety shut-off

For your safety, the appliance has a safety switch-off function. Any heating process is switched off after 24 hours if the appliance controls are not used during this time. All displays are off. When the appliance switches off, a signal tone sounds. The appliance also remains switched off after a power failure.

When the function "Sabbath mode" is active, the the safety shut-off is deactivated.

## 5 Accessories

Only use genuine accessories. These are designed especially for your appliance.

The accessories supplied may differ depending on the appliance model.

## 6 Before using for the first time



Prepare the appliance for use.

### 6.1 Cleaning and heating up the appliance before using it for the first time

**Note:** When the appliance is switched on for the first time, it takes approx. 60 seconds until the appliance is ready to use. A signal tone sounds. The touch fields light up in ascending order from left to right.

**Requirement:** There are no objects in the appliance.

1. Pull the handle on the front panel and open the appliance.

2. Clean the appliance with a damp cloth and neutral cleaning agents, such as dish soap and water.
3. Press .
- ✓ A signal tone sounds.
4. Press .
5. Press 180 °F (80 °C) and close the appliance.
- ✓ The operation indicator flashes while the appliance is preheating.
6. Heat up the appliance at 180 °F (80 °C) for an hour. Smoke development and odor development are normal. Ventilate the installation room well.

## 7 Cookware

Observe the instructions for filling the appliance. The warming drawer has a maximum load capacity of 55 lbs (25 kg). You can heat a different quantity of cookware depending on the appliance height.

### 7.1 Cookware for appliances with a height of 8½" (21.5 cm)

You can use an appliance with a height of 8½" (21.5 cm) to preheat the place settings for 9 people, for example.

Cookware	Dimensions
9 dinner plates	10½" (27 cm) diameter
9 soup bowls	5" (13 cm) diameter
1 bowl	9½" (24 cm) diameter

Cookware	Dimensions
1 bowl	8¼" (21 cm) diameter
1 bowl	6½" (17 cm) diameter
2 meat platters	12½"x7¾" (32x20 cm)

## 8 Basic Operation

### 8.1 Opening the appliance

#### WARNING

The rear of the front panel becomes very hot during operation.

- ▶ To open the appliance, pull the handle on the front panel.
- ▶ Pull the handle on the front panel and open the appliance.

### 8.2 Closing the appliance

- ▶ Push the front panel closed at the handle with a slight swing.
- ✓ The appliance slowly pulls the front panel into the unit.

### 8.3 Switching on the appliance

1. Press .
- ✓ A signal tone sounds.
2. Select an operating mode.
- ✓ The default temperature lights up in color.
- ✓ The available temperatures light up.
3. If required, select another temperature.
- ✓ The selected temperature lights up in color.
4. Close the appliance.

### 8.4 Switching off the appliance

- ▶ Press .
- ✓ A signal tone sounds.









### 8.5 Setting the temperature

1. Press .
- ✓ The default temperature lights up in color.
- ✓ The temperatures that can be set light up white.
2. Select a temperature.
- ✓ The selected temperature lights up in color.



### 8.6 Adjusting the default temperature

1. Select the operating mode.
2. Press and hold the symbol for the required default temperature until the signal tone sounds.
- ✓ The default temperature has changed.

### 8.7 Starting the "Sabbath mode" function

1. Press .
- ✓ A signal tone sounds.
2. Press .
- ✓ The default temperature lights up in color.
3. Set the desired temperature between 80°F and 180°F (30°C) and (80°C).
4. Press  and  at the same time.
- ✓  lights up in color. 80° lights up white.
5. Press 80°.
- ✓ 80° lights up in color.
6. Press and hold  until a signal sounds.
- ✓  lights up white.
- ✓  and the set temperature light up in color. The brightness of the display is dimmed.
7. Close the appliance.
- ✓ The operation indicator lights up, the appliance heats up, and the fan runs.
- ✓ If you open the appliance for this function, the appliance continues to heat up and the fan runs.

### 8.8 Ending the "Sabbath mode" function

1. Press .
- ✓ The "Sabbath mode" function has ended.
2. Press  again to switch off the appliance.
- ✓ A signal tone sounds.

**Tip:** If you have connected the appliance to Home Connect®, you can program a switch-off timer in the Home Connect® app.

## 9 Preheating tableware

Food remains warm for longer in preheated tableware.

### 9.1 Starting the "Preheat tableware" function

1. Place the tableware in the appliance.
  - ▶ To guarantee that hot air can circulate efficiently, ensure that no tall items of tableware or stacks of plates are blocking the ventilation slots on the rear wall of the appliance.

- ▶ Distribute the tableware across the entire bottom of the appliance to reduce the preheating time. The preheating time depends on the material, thickness, quantity, and distribution of the tableware. For place settings for 6 people, the preheating time is approx. 30-40 minutes.
- 2. Press .
- ✓ The default temperature lights up in color.
- ✓ The available temperatures light up.

3. If required, select another temperature.
4. Close the appliance.
- ✓ The operation indicator flashes while the appliance is preheating.
- ✓ The operation indicator lights up, the appliance heats up, and the fan runs.

## 9.2 Ending the "Preheat tableware" function

### WARNING

The accessories and tableware become very hot during operation.

- ▶ Always use oven gloves when removing hot accessories or tableware from the appliance.

1. Open the appliance.
2. Switch off the appliance.
3. Remove the tableware.

---

# 10 Preheating cups

Drinks remain warm for longer in preheated cups.

## 10.1 Starting the "Preheat cups" function

### WARNING

There is a risk of burns if the temperatures are too high.

- ▶ Always set temperatures below 140 °F (60 °C) for cups.

1. Place the cups in the appliance.
  - ▶ Distribute the cups across the entire bottom of the appliance to reduce the preheating time.The preheating time depends on the material, thickness, quantity, and distribution of the cups.
2. Press .
- ✓ The default temperature lights up in color.
- ✓ The available temperatures light up.

3. If required, select another temperature.
4. Close the appliance.

- ✓ The operation indicator flashes while the appliance is preheating.
- ✓ The operation indicator lights up, the appliance heats up, and the fan runs.

## 10.2 Ending the "Preheat cups" function

### WARNING

The accessories and tableware become very hot during operation.

- ▶ Always use oven gloves when removing hot accessories or tableware from the appliance.

1. Open the appliance.
2. Switch off the appliance.
3. Remove the cups.

---

# 11 Keeping food warm

You can use the appliance to keep food warm for a certain period of time.

Note the recommended settings.

→ "Recommended settings for keeping food warm", Page 12

## 11.1 Starting the "Keep food warm" function

1. To prevent spillage, do not completely fill the tableware.
2. Cover the food with heat-resistant cling film, aluminum foil or a heat-resistant cover.
3. Place the tableware in the appliance.
4. Press .
- ✓ The default temperature lights up in color.
- ✓ The available temperatures light up.

5. If required, select another temperature.

6. Close the warming drawer.

- ✓ The operation indicator flashes while the appliance is preheating.
- ✓ The operation indicator lights up, the appliance heats up and the fan runs.

## 11.2 Ending the "Keep food warm" function

### WARNING

The accessories and tableware become very hot during operation.

- ▶ Always use oven gloves when removing hot accessories or tableware from the appliance.

1. Open the appliance.
2. Switch off the appliance.
3. Remove the tableware.

---

# 12 Low-temperature cooking

Low-temperature cooking is the ideal cooking method for cooking all tender pieces of meat which are to be cooked medium rare or "à point". The meat remains very juicy and turns out as soft as butter. Since the times for low-temperature cooking are considerably longer, you have plenty of leeway for menu planning.

Meat that is cooked at a low temperature is easy to keep warm.

Note the recommended settings.

→ "Recommended settings for low-temperature cooking", Page 12

## 12.1 Tips for low-temperature cooking

Here you will find tips for achieving good results when cooking at a low temperature.

- Only use fresh, good-quality meat. Carefully remove sinews and fat from around the edge. Fat develops a strong, distinct taste during low-temperature cooking.
- Even larger joints of meat do not need to be turned.
- You can cut the meat immediately after low-temperature cooking. No standing time is required.
- Due to the special cooking method, the meat always looks pink on the inside. This does not mean, however, that the meat is raw or not well done enough.
- Meat that is cooked at a low temperature is not as hot as conventionally roasted meat. Ensure that the sauces are very hot when you serve them. Place the plates in the appliance in the last 20-30 minutes.
- If you want to keep meat that is cooked at a low temperature warm, select 140 °F (60 °C). Small pieces of meat can be kept warm for up to 45 minutes and large pieces for up to 2 hours.

## 12.2 Starting the "Low-temperature cooking" function

1. Only use suitable cookware made from glass, porcelain, or ceramic with lid, e.g. a glass roasting dish.
2. If no lid is available for the cookware, use heat-resistant plastic wrap to cover the cookware.
3. Place the cookware on the bottom of the appliance.
4. Press  to preheat the cookware.

5. Close the appliance.
- ✓ The operation indicator flashes while the appliance is preheating.
- ✓ The operation indicator lights up, the appliance heats up, and the fan runs.
6. Rapidly heat a little fat in a pan.
7. Sear the meat.
8. Place the meat into the preheated cookware.
9. Put the lid on the cookware or cover it using heat-resistant plastic wrap.
10. Place the cookware with the meat in the appliance.
11. Press .
- ✓ The default temperature lights up in color.
- ✓ The available temperatures light up.
12. If required, select another temperature.
13. Close the appliance.
- ✓ The operation indicator flashes while the appliance is preheating.
- ✓ The operation indicator lights up, the appliance heats up, and the fan runs.

## 12.3 Ending the "Low-temperature cooking" function

### WARNING

The accessories and tableware become very hot during operation.

- ▶ Always use oven gloves when removing hot accessories or tableware from the appliance.

1. Open the appliance.
2. Switch off the appliance.
3. Remove the tableware.

# 13 Additional applications

Your appliance offers additional useful applications.

Note the recommended settings.

→ "Recommended settings for other applications", Page 13

## 14 Defrosting

You can use your appliance to defrost frozen food gently and more evenly than in the microwave.

Note the recommended settings.

→ "Recommended settings for defrosting", Page 13

### 14.1 Defrosting food

#### WARNING

When defrosting food from animal sources, the transmission of germs is possible.

- ▶ When defrosting food from animal sources, you must remove the liquid that escapes during defrosting.
- ▶ Ensure that the liquid that escapes during defrosting never comes into contact with other foods.

1. Remove the food from the packaging before defrosting.

2. Only defrost the amount of food that you require immediately.
3. After half the defrost time has elapsed, turn the meat or fish.
4. Break up frozen clumps of food comprising many pieces, e.g. berries and pieces of meat.

#### Notes

- The defrosting time depends on the size, weight and shape of the frozen food. To reduce the defrosting time, freeze food flat or in individual portions.
- In some cases, defrosted food may no longer be kept for as long and it may spoil more quickly than fresh food. Prepare defrosted food immediately and cook it thoroughly.
- Fish does not need to be fully defrosted. It is sufficient to defrost fish until the surface is soft enough for seasoning/spices to stick.

## 15 How it works

### 15.1 Recommended settings for keeping food warm

Observe the following recommended settings when keeping food warm. To prevent the food from drying out, observe the maximum duration in the overview.

Food	Preheating tableware	Temperature in °F (°C)	Duration in minutes	Notes
Boiled eggs, scrambled eggs	yes	120 (50)	maximum 60	Cover the food
Toasting bread, rolls	yes	140 (60)	maximum 60	
Delicate foods, e.g. cooked meat	no	140 (60)	maximum 60	Carve the meat just before serving; cover the food
Food	yes	180 (80)	maximum 60	Cover the food
Drinks	yes	160 (70)	maximum 60	Cover drinks

### 15.2 Recommended settings for low-temperature cooking

The following settings have been specially tested for your appliance.

All tender joints of beef, pork, veal, lamb, game and poultry are suitable for low-temperature cooking. The searing and cooking times depend on the size of the piece of meat. The searing times apply to food placed into the hot oil.

#### Small pieces of meat

Food	Searing time on the cooking zone	Continued cooking time in the warming drawer	Temperature in °F (°C)
Cubes or strips	On all sides for 1-2 minutes	20-30 minutes	180 (80)
Small escalopes, steaks or medallions, approx. $\frac{3}{8}$ " - $\frac{3}{4}$ " (1-2 cm) thick	1-2 minutes per side	35-50 minutes	180 (80)

#### Medium-sized pieces of meat

Food	Searing time on the cooking zone	Continued cooking time in the warming drawer	Temperature in °F (°C)
Fillet, 0.8 - 1.8 lbs (400-800 g)	On all sides for 4-5 minutes	75-120 minutes	180 (80)
Saddle of lamb, approx. 1 lb (450 g)	2-3 minutes per side	50-60 minutes	180 (80)
Lean joints of meat, 1.8 - 2.2 lbs (800-1000 g)	On all sides for 6-8 minutes	120-180 minutes	180 (80)

#### Large pieces of meat

Food	Searing time on the cooking zone	Continued cooking time in the warming drawer	Temperature in °F (°C)
Fillet, from 1.8 - 4.4 lbs (800-2000 g)	On all sides for 6-8 minutes	120-210 minutes	180 (80)
Sirloin, 2.2 - 4.4 lbs (1-2 kg)	On all sides for 8-10 minutes	180-210 minutes	180 (80)

#### Other food

Food	Searing time on the cooking zone	Continued cooking time in the warming drawer	Temperature in °F (°C)	Notes
Ragout	On all sides for 6-8 minutes	15 hours	180 (80) 80	In the roasting dish with lid

<b>Food</b>	<b>Searing time on the cooking zone</b>	<b>Continued cooking time in the warming drawer</b>	<b>Temperature in °F (°C)</b>	<b>Notes</b>
Confit meat		20 hours	180 (80)	In the roasting dish with lid, e.g. confit de canard (speciality from South-West France)

### 15.3 Recommended settings for other applications

Observe the following recommended settings.

#### Warming

<b>Food</b>	<b>Temperature in °F (°C)</b>	<b>Duration in minutes</b>	<b>Notes</b>
Egg and flour-based foods, e.g. crêpes, pancakes, wraps, tacos	180 (80)	10-60	Cover the food
Cakes, e.g. cakes with crumble topping, muffins	180 (80)	30-45	Cover the food

#### Melting

<b>Food</b>	<b>Temperature in °F (°C)</b>	<b>Duration in minutes</b>	<b>Notes</b>
Dissolving gelatin	180 (80)	10-15	Before melting the gelatine leaves, soak them in water and wring them out
Cooking chocolate or couverture chocolate	140 (60)	30-45	Break the chocolate into pieces
Butter	180 (80)	30-45	Cut the butter into cubes

#### Drying

<b>Food</b>	<b>Temperature in °F (°C)</b>	<b>Duration in minutes</b>	<b>Notes</b>
Fresh herbs	140 (60)	90	
Meringues	180 (80)	150-180	1 ¼" - 1 ½" (3-4 cm) diameter
Apple rings	160 (70)	420-480	Cut the apples into thin slices or rings

#### Flavoring oil

<b>Food</b>	<b>Temperature in °F (°C)</b>	<b>Duration in minutes</b>	<b>Notes</b>
Flavored oil	180 (80)	90-120	E.g. olive oil with lemon, rosemary, chilli

#### Heating cotton cloths

<b>Table linen</b>	<b>Temperature in °F (°C)</b>	<b>Duration in minutes</b>	<b>Notes</b>
Hot cotton cloths	180 (80)	60	Moisten and roll up the cotton cloths before heating. Add the cotton cloths to a plate or cooking container. Place the plate or the cooking container in the warming drawer.

### 15.4 Recommended settings for defrosting

Take note of the following recommended settings for defrosting food.

Food	Temperature in °F (°C)	Duration in minutes
Delicate frozen food, e.g. butter, cheese, berries	100 (40)	45-60
Bread, bread rolls, baguettes, cake	140 (60)	15-30
Meat, fish	140 (60)	30-60

## 16 Home Connect®

This appliance is network-capable. Connecting your appliance to a mobile device lets you control its functions via the Home Connect® app, adjust its basic settings and monitor its operating status.

The Home Connect® services are not available in every country. The availability of the Home Connect® function depends on the availability of the Home Connect® services in your country. You can find information on this at: [www.home-connect.com](http://www.home-connect.com).

The Home Connect® app guides you through the entire registration process. Follow the instructions, noting the information in the Home Connect® app.

### Notes

- Note the safety information in this instruction manual and ensure that it is also observed when operating the appliance using the Home Connect® app.
- Operating the appliance on the appliance itself always takes priority. It is not possible to operate the appliance using the Home Connect® app during this time.
- In networked standby mode, the appliance requires a maximum of 2 watts.

### 16.1 Setting up Home Connect®

#### Requirements

- The appliance is connected to the power supply and is switched on.
- You have a mobile device with a current version of the iOS or Android operating system, e.g. a smartphone.
- The appliance receives signals from the WLAN home network (Wi-Fi) at its installation location.
- The mobile device and the appliance are within range of your home network's Wi-Fi signal.

1. Scan the following QR code.



You can install the Home Connect® app and connect your appliance via the QR code.

2. Follow the instructions in the Home Connect® app.

### 16.2 Resetting the Wi-Fi settings and switching off the Wi-Fi

1. Press and hold until a signal tone sounds.
  - ✓ flashes white once.
  - ✓ The Wi-Fi is reset. The appliance searches for a connection to another mobile device.
2. Press and hold until a signal tone sounds.
  - ✓ lights up for approximately 2 seconds.
  - ✓ The Wi-Fi is switched off.

### 16.3 Software update

Your appliance's software can be updated using the software update function, e.g. for the purposes of optimization, troubleshooting or security updates. To do this, you must be a registered Home Connect® user, have installed the app on your mobile device and be connected to the Home Connect® server. As soon as a software update is available, you will be informed via the Home Connect® app and will be able to start the software update via the app. Once the update has been successfully downloaded, you can start installing it via the Home Connect® app if you are in your home network (Wi-Fi). The Home Connect® app informs you once the installation is successful.

#### Notes

- The software update consists of two steps.
  - The first step is the download.
  - The second step is the installation on your appliance.
- You can continue to use your appliance as normal while updates are downloading. Depending on your personal settings in the app, software updates can also be set to download automatically.
- Installation takes a few minutes. You cannot use your appliance during installation.
- We recommend that you install security updates as soon as possible.

### 16.4 Data Protection

Please read this information on data protection.

The first time your appliance is registered on a home network connected to the Internet, your appliance transmits the following types of data to the Home Connect® server (initial registration):

- Unique appliance identification (consisting of appliance codes as well as the MAC address of the installed Wi-Fi communication module).
- Security certificate of the Wi-Fi communication module (to ensure a secure data connection).
- The current software and hardware version of your home appliance.

- Status of any previous reset to factory settings.

This initial registration prepares the Home Connect® functions for use and is only required when you want to use the Home Connect® functions for the first time.

**Note:** Please note that the Home Connect® functions can only be used in conjunction with the Home Connect® app. Information on data protection can be retrieved in the Home Connect® app.

## 17 Cleaning and maintenance

**Note:** The Statement of Limited Product Warranty covers defects in materials and workmanship. Cleaning and maintenance is not covered by the warranty and a charge will apply. See the Statement of Limited Product Warranty for more details.

### 17.1 Cleaning agents

You can obtain suitable cleaning products from Customer Service or the online shop.

#### **NOTICE**

Unsuitable cleaning agents may damage the surfaces of the appliance.

- ▶ Do not use strong or abrasive cleaning agents.
- ▶ Do not use cleaning agents with a high alcohol content.
- ▶ Do not use hard scouring pads or cleaning sponges.
- ▶ Only use glass cleaners, glass scrapers or stainless steel care products if recommended in the cleaning instructions for the relevant part.
- ▶ Wash sponge cloths thoroughly before use.

### 17.2 Cleaning the appliance

#### **⚠ WARNING**

Moisture entering the appliance may cause electrical shock.

- ▶ Do not use any steam cleaners or high-pressure cleaners to clean the appliance.

- ▶ Do not use the appliance with damp hands.

#### **⚠ WARNING**

The appliance becomes hot during operation.

- ▶ Allow the appliance to cool down before cleaning.

**Requirement:** The appliance is switched off.

1. Clean the appliance with a damp cloth and neutral cleaning agents, such as dish soap and water.
2. Dry with a soft cloth.

### 17.3 Cleaning the stainless steel surfaces

1. Always remove limescale, grease, starch or albumin stains immediately.  
Corrosion may form under such stains.
2. Clean with water and some dish soap.
3. Dry with a soft cloth.

### 17.4 Cleaning the glass plate

1. Clean the glass plate using a glass cleaning product and a soft cloth.
  - ▶ Do not use any abrasive sponges that may scratch or any glass scrapers.
2. Dry with a soft cloth.

## 18 Troubleshooting

You can eliminate minor issues on your appliance yourself. Please read the information on eliminating issues before contacting Customer Service. This may avoid unnecessary repair visits.

#### **⚠ WARNING**

To avoid risk of injury from improper repairs, observe the following.

- ▶ Only qualified technicians or authorized service providers should perform repairs.
- ▶ If the power cord or the appliance power cable of this appliance becomes damaged, it must be replaced with a special power cord or special appliance power cable, which is available from the manufacturer or the manufacturer's Customer Service.
- ▶ If the power cord of this appliance is damaged, it must be replaced by trained, specialist personnel.
- ▶ Only genuine spare parts may be used to repair the appliance.
- ▶ If the appliance has an issue, call Customer Service.

### 18.1 Malfunctions

Fault	Cause and troubleshooting
The tableware or food is not heating up.	There has been a power failure. <ul style="list-style-type: none"> <li>▶ Check whether the lighting in your kitchen or other appliances in the room are working.</li> </ul>
	The appliance is switched off. <ul style="list-style-type: none"> <li>▶ Switch on the appliance.</li> </ul>





Fault	Cause and troubleshooting
The tableware or food is not heating up.	<p>The appliance is not completely closed.</p> <ul style="list-style-type: none"> <li>▶ Close the appliance.</li> </ul> <hr/> <p>The tableware covers the ventilation system slots and the appliance switches on the overheating protection.</p> <ol style="list-style-type: none"> <li>1. Wait until the appliance has cooled down.</li> <li>2. Ensure that the ventilation slots on the back wall of the appliance are not covered.</li> <li>3. Use the main switch to switch the appliance off and back on again.</li> <li>4. Select the required operating mode and temperature.</li> </ol>
The appliance is not working.	<p>The circuit breaker in the circuit breaker panel has tripped.</p> <ul style="list-style-type: none"> <li>▶ Check the breaker panel.</li> </ul>
The tableware or food does not get warm enough.	<p>There has been a power failure.</p> <ul style="list-style-type: none"> <li>▶ Check whether the lighting in your kitchen or other appliances in the room are working.</li> </ul> <hr/> <p>The cookware or food has not been heated for long enough.</p> <ul style="list-style-type: none"> <li>▶ Heat the tableware or the food for a longer period of time.</li> </ul> <hr/> <p>The appliance is not completely closed.</p> <ul style="list-style-type: none"> <li>▶ Close the appliance.</li> </ul>
The appliance switches off. All displays are off.	<p>The safety shut-off has switched the appliance off.</p> <ul style="list-style-type: none"> <li>▶ Switch the appliance back on.</li> </ul>
The operation indicator flashes.	<p>The appliance heats up.</p> <ul style="list-style-type: none"> <li>▶ Wait until the appliance has finished heating up.</li> </ul>
The appliance is switched on. The operation indicator does not light up.	<p>The operation indicator is defective.</p> <ul style="list-style-type: none"> <li>▶ Call customer service → <i>Page 17</i>.</li> </ul>
The fuse in the fuse box has blown.	<p>The circuit breaker in the circuit breaker panel has tripped.</p> <ul style="list-style-type: none"> <li>▶ Call customer service → <i>Page 17</i>.</li> </ul>
The indicators light up. The appliance does not heat up.	<p>Demo mode is activated.</p> <ul style="list-style-type: none"> <li>▶ Deactivate demo mode. → <i>Page 16</i></li> </ul>
Home Connect display flashes in color.	<p>Network fault</p> <ol style="list-style-type: none"> <li>1. Check the connection to the home network, e.g. with a mobile phone near the appliance.</li> <li>2. Restart the router.</li> </ol> <ul style="list-style-type: none"> <li>▶ If the problem persists, contact Customer Service.</li> </ul> <p>→ "<i>Customer Service</i>", <i>Page 17</i></p>
The front panel is not aligned.	<p>The front panel was not aligned during installation.</p> <ul style="list-style-type: none"> <li>▶ Adjust the front panel.</li> </ul>
The lighting does not work.	<p>The lighting is not activated in the Home Connect® app.</p> <ul style="list-style-type: none"> <li>▶ Change the settings in the Home Connect® app.</li> </ul>

## 18.2 Demo mode

If demo mode is activated, the indicators light up but the appliance does not heat up.

### Deactivating demo mode

1. Briefly disconnect the appliance from the mains.
  - ▶ Unplug the appliance from the mains or switch off the household fuse or circuit breaker in the fuse box.

2. Deactivate demo mode within the next 3 minutes.
  - ▶ Press and hold  and  at the same time until  and 30° light up in color.
  - ▶ Press 30° until 30° lights up white.
3. To save the settings, press and hold  until all indicators go out.

# 19 Information regarding Free and Open Source Software

This product includes software components that are licensed by the copyright holders as free or open source software.

The applicable license information is stored on your home appliance. You can also access the applicable li-

cense information via your Home Connect® app: "Profile -> Legal information -> License Information". You can also download the license information on the brand product website. (Please search on the product website for your appliance model and additional documents). Al-

ternatively, you can request the relevant information from [ossrequest@bshg.com](mailto:ossrequest@bshg.com) or BSH Hausgeräte GmbH, Carl-Wery-Str. 34, 81739 Munich, Germany.

The relevant source code will be made available to you on request.

Please send your request to [ossrequest@bshg.com](mailto:ossrequest@bshg.com) or BSH Hausgeräte GmbH, Carl-Wery-Str.34, 81739 Munich, Germany.

## 20 Customer Service

With any warranty repair, we will make sure your appliance is repaired by an authorized service provider using genuine replacement parts. We use only genuine replacement parts for all repairs.

You can obtain function-relevant and storable genuine spare parts from our Customer Service for up to 15 years from the date on which your appliance was placed on the market.

For more information, please contact our Customer Service team.

Detailed information on the warranty period and terms of warranty can be found in the Statement of Limited Product Warranty, from your retailer, or on our website.

The LED light sources are available as a spare part and should only be replaced by an authorized service provider.

USA:

1-877-442-4436

[www.gaggenau.com](http://www.gaggenau.com)

[www.gaggenau.com/us/appliances/eshop](http://www.gaggenau.com/us/appliances/eshop)

CA:

1-877-442-4436

[www.gaggenau.com](http://www.gaggenau.com)

[www.gaggenau.ca](http://www.gaggenau.ca)

For assistance with connecting to Home Connect®, you can also view instructions here:

[www.home-connect.com/us/en/help-support/set-up](http://www.home-connect.com/us/en/help-support/set-up)

Subject: „OSSREQUEST“

The cost of performing your request will be charged to you. This offer is valid for three years from the date of purchase or at least as long as we offer support and spare parts for the relevant appliance.

### 20.1 Model number (E-Nr.), production number (FD) and consecutive numbering (Z-Nr.)

You can find the model number (E-Nr.), the production number (FD) and the consecutive numbering (Z-Nr.) on the appliance's rating plate.

Making a note of your appliance's details and the Customer Service telephone number will enable you to find them again quickly.

### 20.2 Rating plate location

You can find the rating plate of your appliance:

- at the right side of the drawer. Open the drawer to view it.

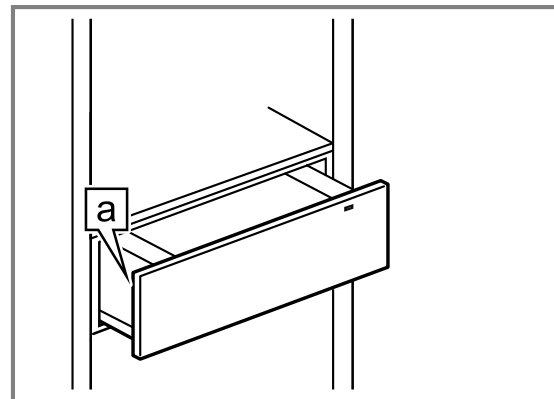

**a** Rating plate

## 21 Disposal

### 21.1 Disposal of your old appliance

Environmentally compatible disposal allows valuable raw materials to be recycled.

1. Unplug the appliance from the power supply.

2. Cut through the power cord.

3. Dispose of the appliance in an environmentally responsible manner.

Information about current disposal methods can be obtained from your specialist dealer or local authority.

## 22 STATEMENT OF LIMITED PRODUCT WARRANTY

### 22.1 What this warranty covers & Who it applies to

The limited warranty provided by BSH Home Appliances ("Gaggenau") in this Statement of Limited Product Warranty applies only to the Gaggenau appliance sold to

you ("Product"), provided that the Product was purchased on or after January 1, 2025:

- For your normal, household (non-commercial) use, and has in fact at all times only been used for normal household purposes.

- New at retail from a BSH authorized dealer or directly from BSH (not a display, "as is", or previously returned model), and not for resale, or commercial use.
- Within the United States or Canada, and has at all times remained within the country of original purchase.

The warranties stated herein apply to the original purchaser of the product warranted herein and to each succeeding owner of the product purchased for ordinary home use during the term of the warranty. Please make sure to register your Product; while not necessary to effectuate warranty coverage, it is the best way for Gaggenau to notify you in the unlikely event of a safety notice or product recall.

## 22.2 How long the warranty lasts

Gaggenau warrants that the Product is free from defects in materials and workmanship for a period of five (5) years from the date of the original delivery. The warranty shall only be extended for the time that elapsed between the date of your warranty claim and the date of the completed repair or replacement. This Product is also warranted to be free from **cosmetic** defects in material and workmanship (such as scratches of stainless steel, paint/porcelain blemishes, chips, dents, or other damage to the finish) of the Product, for a period of sixty (60) days from the date of delivery or closing date for new construction. This **cosmetic** warranty excludes slight color variations due to inherent differences in painted and porcelain parts, as well as differences caused by kitchen lighting, product location, or other similar factors. This **cosmetic** warranty specifically excludes any display, floor, "As Is", or "B" stock appliances.

## 22.3 Repair/replace as your exclusive remedy

During this warranty period, Gaggenau or one of its authorized service providers will repair your Product without charge to you (subject to certain limitations stated herein) if your Product proves to have been manufactured with a defect in materials or workmanship. If reasonable attempts to repair the Product have been made without success, then Gaggenau will replace your Product (upgraded models may be available to you, in Gaggenau's sole discretion, for an additional charge). Nothing in this warranty requires damaged or defective parts to be replaced with parts of a different type or design than the original parts. All removed parts and components shall become the property of Gaggenau at its sole option. All replaced and/or repaired parts shall assume the identity of the original part for purposes of this warranty and this warranty shall not be extended with respect to such parts. Gaggenau's sole liability and responsibility hereunder is to repair manufacturer-defective Product only, using a Gaggenau authorized service provider during normal business hours. For safety and property damage concerns, Gaggenau highly recommends that you do not attempt to repair the Product yourself, or use a non-authorized service provider; Gaggenau will have no responsibility or liability for damage resulting from repairs or work performed by a non-authorized service provider. Authorized service

providers are those persons or companies that have been specially trained on Gaggenau products, and who possess, in Gaggenau's opinion, a superior reputation for customer service and technical ability (note that they are independent entities and are not agents, partners, affiliates or representatives of Gaggenau). Nevertheless, taking your product to be serviced by a repair shop that is not affiliated with or an authorized dealer of Gaggenau will not void this warranty. Also, using third-party parts will not void this warranty. Notwithstanding the foregoing, Gaggenau will not incur any liability, or have responsibility, for the Product if it is located in a remote area (more than 100 miles from an authorized service provider) or is reasonably inaccessible, hazardous, threatening, or treacherous locale, surroundings, or environment; in any such event, if you request, Gaggenau would still pay for labor and parts and ship the parts to the nearest authorized service provider, but you would still be fully liable and responsible for any travel time or other special charges by the service company, assuming they agree to make the service call. Further, to the extent you have installed the Product in a difficult-to-access location or have otherwise installed temporary or permanent fixtures that create barriers to accessing or removing the Product, Gaggenau will not incur any liability for, or have responsibility, for work or costs associated with moving the Product or otherwise creating access to the Product in order to repair or replace it. All such costs shall be your sole responsibility.

## 22.4 Out of warranty product

Gaggenau is under no obligation, at law or otherwise, to provide you with any concessions, including repairs, prorates, or Product replacement, once this warranty has expired.

## 22.5 Warranty exclusions

The warranty coverage described herein excludes all defects or damage that are not the direct fault of Gaggenau, including without limitation, one or more of the following:

- Use of the Product in anything other than its normal, customary and intended manner (including without limitation, any form of commercial use, use or storage of an indoor product outdoors, use of the Product in conjunction with air or water-going vessels).
- Any party's willful misconduct, negligence, misuse, abuse, accidents, neglect, improper operation, failure to maintain, improper or negligent installation, tampering, failure to follow operating instructions, mishandling, unauthorized service (including selfperformed "fixing" or exploration of the appliance's internal workings).
- Adjustment, alteration or modification of any kind.
- A failure to comply with any applicable state, local, city, or county electrical, plumbing and/or building codes, regulations, or laws, including failure to install the product in strict conformity with local fire and building codes and regulations.
- Ordinary wear and tear, spills of food, liquid, grease accumulations, or other substances that accumulate on, in, or around the Product.

- Any external, elemental and/or environmental forces and factors, including without limitation, rain, wind, sand, floods, fires, mud slides, freezing temperatures, excessive moisture or extended exposure to humidity, lightning, power surges, structural failures surrounding the appliance, and acts of God.
- Service calls to correct the installation of your Product, to instruct you how to use your Product, to replace house fuses or correct house wiring or plumbing.
- Removal and replacement of trim or decorative panels that interfere with servicing the Product.
- Damage or defects caused by labor or parts installed by any non-authorized service provider, unless approved by Gaggenau before service is performed.

In no event shall Gaggenau have any liability or responsibility whatsoever for damage to surrounding property, including cabinetry, floors, ceilings, and other structures or objects around the Product. Also excluded from this warranty are Products, on which the serial numbers have been altered, defaced, or removed; service visits to teach you how to use the Product, or visits where there is nothing wrong with the Product; correction of installation problems (you are solely responsible for any structure and setting for the Product, including all electrical, plumbing or other connecting facilities, for proper foundation/flooring, and for any alterations including without limitation cabinetry, walls, floors, shelving, etc.); and resetting of breakers or fuses.

TO THE EXTENT ALLOWED BY LAW, THIS WARRANTY SETS OUT YOUR EXCLUSIVE REMEDIES WITH RESPECT TO PRODUCT, WHETHER THE CLAIM ARISES IN CONTRACT OR TORT (INCLUDING STRICT LIABILITY, OR NEGLIGENCE) OR OTHERWISE. THIS WARRANTY IS IN LIEU OF ALL OTHER WARRANTIES, WHETHER EXPRESS OR IMPLIED. ANY WARRANTY IMPLIED BY LAW, WHETHER FOR MERCHANTABILITY OR FITNESS FOR A PARTICULAR PURPOSE, OR OTHERWISE, SHALL BE EFFECTIVE ONLY FOR THE PERIOD THAT THIS EXPRESS LIMITED WARRANTY IS EFFECTIVE. IN NO EVENT WILL THE MANUFACTURER BE LIABLE FOR CONSEQUENTIAL, SPECIAL, INCIDENTAL, INDIRECT, "BUSINESS LOSS", AND/OR PUNITIVE DAMAGES, LOSSES, OR EXPENSES, INCLUDING WITHOUT LIMITATION TIME AWAY FROM WORK, HOTELS AND/OR RESTAURANT MEALS, REMODELLING EXPENSES IN EXCESS OF DIRECT DAMAGES WHICH ARE DEFINITELY CAUSED EXCLUSIVELY BY GAGGENAU, OR OTHERWISE. SOME STATES DO NOT ALLOW THE EXCLUSION OR LIMITATION OF INCIDENTAL OR CONSEQUENTIAL DAMAGES, AND SOME STATES DO NOT ALLOW LIMITATIONS ON HOW LONG AN IMPLIED WARRANTY LASTS, SO THE ABOVE EXCLUSIONS OR LIMITATIONS MAY NOT APPLY TO YOU. THIS WARRANTY GIVES YOU SPECIFIC LEGAL RIGHTS, AND YOU MAY ALSO HAVE OTHER RIGHTS WHICH VARY FROM STATE TO STATE.

No attempt to alter, modify or amend this warranty shall be effective unless authorized in writing by an officer of BSH.

## 22.6 Obtaining warranty service

To obtain warranty service for your product, you should contact Gaggenau Customer Support at 1-877-442-4436 to schedule a repair.

## 22.7 Product information

For handy reference, copy the information below from the rating plate. Keep your invoice and/or delivery documents for warranty validation.

---

Model number (E-Nr.)

---

Production number (FD)

---

Date of delivery

---

The difference is Gaggenau

[gaggenau.com](http://gaggenau.com)

**BSH Home Appliances Corporation**

1901 Main Street, Suite 600

Irvine, CA 92614

USA

[www.gaggenau.com](http://www.gaggenau.com)

1-877-442-4436

© 2026 BSH Home Appliances Corporation



**9001894425** (060401)

en-us