

Electric Cooktop

User manual

NZ36K7570R*



SAMSUNG

Contents

Important safety instructions **3**

What you need to know about safety instructions	3
For your safety	4
Surface cooking units	5
Electrical safety	6
Child safety	7
Ventilating hood	7
Glass/ceramic cooking surfaces	7
Critical installation warnings	8
Critical usage warning	9
Usage cautions	10
Critical cleaning warnings	11
California Proposition 65 Warning	13

Before you start **13**

About surface cooking	13
Location of the surface elements and controls	14

Operations **16**

Switching the appliance on	16
Select the cooking zone and heat setting	16
Switching the appliance off	19
Using the child lock	19
Timer	20
Sync control	20
Sound on/off	21
Using the proper cookware	21
Choosing the proper cookware	22
Protecting the cooktop	22
Using the smart connect feature	23
Using the hood control feature	23

Maintenance **24**

Care and cleaning of the glass cooktop	24
--	----

Troubleshooting **26**

Troubleshooting	26
Information codes	27

Warranty (U.S.A) **28**

Warranty (CANADA) **29**

Appendix **31**

Open Source Announcement	31
Model name & serial number	31

Important safety instructions

Read and follow all instructions before using your cooktop to prevent the risk of fire, electric shock, personal injury, or damage when using the cooktop. This guide does not cover all possible conditions that may occur. Always contact your service agent or the manufacturer about problems that you do not understand.

WHAT YOU NEED TO KNOW ABOUT SAFETY INSTRUCTIONS

Warnings and Important safety instructions in this manual do not cover all possible conditions and situations that may occur. It is your responsibility to use common sense, caution, and care when installing, maintaining, and operating your cooktop.

Important safety symbols and precautions

What the icons and signs in this user manual mean:

WARNING

Hazards or unsafe practices that may result in **severe personal injury or death**.









CAUTION

Hazards or unsafe practices that may result in **minor personal injury or property damage**.

SAVE THESE INSTRUCTIONS

CAUTION

To reduce the risk of fire, explosion, electric shock, or personal injury when using your cooktop, follow these basic safety precautions.

-  Do NOT attempt.
-  Do NOT disassemble.
-  Do NOT touch.
-  Follow directions explicitly.
-  Unplug the power plug from the wall socket.
-  Make sure the machine is grounded to prevent electric shock.
-  Call a Samsung service center for help.
-  Note

These warning signs are here to prevent injury to you and others. Please follow them explicitly.

After reading this section, keep it in a safe place for future reference.



SAVE THESE INSTRUCTIONS

Important safety instructions





FOR YOUR SAFETY

When using electrical appliances, you should follow basic safety precautions, including the following:

CAUTION

- Use this appliance only for its intended purpose as described in this Owner's Manual.
- Potentially hot surfaces include the cooktop, the cooktop facing, and areas near the cooktop.
-  User servicing - Do not repair or replace any part of the appliance unless specifically recommended in this manual. All other servicing should be referred to a qualified technician.
-  Always disconnect the power to the appliance before servicing by removing the fuse or switching off the circuit breaker.
-  • **Do not store items of interest to children in cabinets above the cooktop surface.** Children climbing on the cooktop to reach items could be seriously injured.
- **Do not leave children alone.** Never leave children alone or unattended in an area where this appliance is in use. They should never be allowed to sit or stand on any part of the appliance.
- **Never use your appliance for warming or heating the room.**

SAVE THESE INSTRUCTIONS

-  • **Do not use water on grease fires.** Turn off the cooktop to avoid spreading the flames. Smother the fire or flames or use a dry chemical, baking soda, or foam-type extinguisher.
-  • **Storage in or on the appliance.** Do not store flammable materials near the surface units. Be sure all packing materials are removed from the appliance before operating it. Keep plastics, clothes, and paper away from parts of the appliance that may become hot.
- **Wear proper apparel.** Never wear loose-fitting or hanging garments while using the appliance.
- **Use only dry potholders.** Placing moist or damp potholders on hot surfaces may result in burns from steam. Do not let the potholder touch hot heating elements. Do not use a towel or other bulky cloth.
- Teach children not to play with the controls or any other part of the cooktop.
-  • Be sure your appliance is properly installed and grounded by a qualified technician.
-  • Avoid scratching or striking the cooktop. Doing so may lead to glass breakage. Do not cook on a cooktop with broken glass. Shock, fire, or cuts may occur.
-  • For your safety, do not use high-pressure water cleaners or steam jet cleaners to clean any part of the cooktop.

SAVE THESE INSTRUCTIONS

-
- ★ • If the power cord is damaged, it must be replaced by the manufacturer, its service agent, or similarly qualified persons to avoid creating a hazard.
 - The appliance is not intended for use by persons (including children) with reduced physical, sensory or mental capabilities, or lack of experience and knowledge, unless they have been given supervision or instruction concerning use of the appliance by a person responsible for their safety.
 - Do not lean on the cooktop as you may turn the control knobs inadvertently.

SURFACE COOKING UNITS

- ☒ • **Never leave surface units unattended at high heat settings.** Boilovers cause smoking and greasy spillovers that may ignite.
- Protective Liners – Do not use aluminum foil to line surface unit drip bowls or oven bottoms, except as suggested in the manual. Improper installation of these liners may result in a risk of electric shock or fire.
- **Do not lift the cooktop.** Lifting the cooktop can damage the cooktop and cause the cooktop to malfunction.

SAVE THESE INSTRUCTIONS

-
- ☒ • Never use the glass cooktop surface as a cutting board.
 - ★ • **Use care when touching the cooktop.** The glass surface of the cooktop will retain heat after the controls have been turned off.
 - **Use proper pan sizes.** This appliance is equipped with surface units of different size. Select pots and pans that have flat bottoms large enough to cover the surface area of the heating element. Using undersized cookware will expose a portion of the heating element to direct contact and may result in the ignition of clothing. Matching the size of the pot or pan to the burner will also improve efficiency.
 - **Cookware Handles Should Be Turned Inward and Not Extend Over Adjacent Surface Units** – To reduce the risk of burns, ignition of flammable materials, or spillage due to unintentional contact with cookware, position cookware handles so that they are turned inward and do not extend over adjacent surface units.
 - **Glazed cookware.** Only certain types of glass, glass/ceramic, ceramic, earthenware, or other glazed cookware can be used for rangetop service without breaking due to sudden changes in temperature.
 - Always turn the surface units off before removing cookware.

SAVE THESE INSTRUCTIONS

Important safety instructions

- ★ • Keep an eye on foods being fried at high or medium high heat settings.
- ☐ • To avoid oil spillover and fire, use a minimum amount of oil when shallow pan-frying and avoid cooking frozen foods that have excessive amounts of ice.
- **Do not operate the cooktop without cookware.** If the cooktop operates without cookware, the control knobs will become hot.
- ★ • Do not move the container and bowl in a horizontal position on cooktop surface.
- **Be careful when placing spoons or other stirring utensils on the glass cooktop surface when it is in use.** They may become hot and could cause burns.
- **Cleaning.** Read and follow all instructions and warnings on the cleaning cream labels.
- Be sure you know which control knob operates each surface unit. Make sure you have turned on the correct surface unit.
- When preparing flaming foods under the hood, turn the fan on.
- **Do not store heavy items above the cooktop surface that could fall and damage it.**

SAVE THESE INSTRUCTIONS

- ★ • **Do not Use Decorative Surface Element Covers** - If an element is accidentally turned on, the decorative cover will become hot and possibly melt. Burns will occur if the hot covers are touched. Damage may also be done to the cooktop.

ELECTRICAL SAFETY

Use factory installed flexible cord to connect to power supply only, do not use power supply cord kit.

- ★ • The cooktop should be serviced only by qualified service personnel. Repairs carried out by unqualified individuals may cause injury or a serious malfunction. If your appliance is in need of repair, contact a Samsung authorized service center. Failure to follow these instructions may result in damage and void the warranty.
- Flush - mounted appliances may be operated only after they have been installed in cabinets and workplaces that conform to the relevant standards. This ensures that the appliances are installed in compliance with the appropriate safety standards.
- If your appliance malfunctions or if fractures, cracks, or splits appear:
 - switch off all cooking zones
 - unplug the cooktop from the AC wall outlet
 - contact your local Samsung service center.

SAVE THESE INSTRUCTIONS

⚠ WARNING

If the surface is cracked, switch off and unplug the appliance to avoid the possibility of electrical shock. Do not use your cooktop until the glass surface has been replaced.

CHILD SAFETY

⚠ WARNING

- This appliance is not intended for use by young children or infirm persons without the adequate supervision of a responsible adult.
- Young children should be supervised to ensure that they do not play with the appliance.
- The cooking zones will become hot when you cook. To keep small children from being burned, always keep them away from the appliance while you are cooking.

⚠ WARNING

Accessible parts may become hot during use. To avoid burns, young children should be kept away.

SAVE THESE INSTRUCTIONS

VENTILATING HOOD

- ★ • **Clean ventilating hoods frequently.** Do not let grease accumulate on the hood or filter.
- **When flaming foods under the hood, turn the fan on.**

GLASS/CERAMIC COOKING SURFACES

- ☐ • **DO NOT TOUCH SURFACE UNITS OR AREAS NEAR UNITS.** Surface units may be hot even though they are dark in color. Areas near surface units may become hot enough to cause burns. During and after use, do not touch, or let clothing or other flammable materials contact the surface units or areas near the units until they have had sufficient time to cool. Among these areas are the cook-top and the facing of the cooktop.
- **Do not cook on a broken cooktop.** If the cooktop should break, cleaning solutions and spillovers may penetrate the broken cooktop and create a risk of electric shock. If your cooktop breaks, contact an authorized Samsung service center immediately.
- ★ • **Clean the cooktop with caution.** If a wet sponge or cloth is used to wipe spills on a hot cooking area, be careful to avoid steam burns. Some cleaners can produce noxious fumes if applied to a hot surface.

SAVE THESE INSTRUCTIONS



Important safety instructions

CRITICAL INSTALLATION WARNINGS

WARNING

-  • This appliance must be installed by a qualified technician or service company.
 - Failing to have a qualified technician install the cooktop may result in electric shock, fire, an explosion, problems with the product, or injury.
- Unpack the cooktop, remove all packaging material and examine the cooktop for any damage such as dents. If there is any damage, do not operate the cooktop and notify your dealer immediately.
- Plug the power cord into a properly grounded outlet with the proper configuration. Your cooktop should be the only item connected to this circuit.
- Keep all packaging materials out of the reach of children. Children may use them for play and injure themselves.
- Install the cooktop on a sturdy, level cabinet that can support its weight.
 - Failing to do so may result in problems with the cooktop.

SAVE THESE INSTRUCTIONS

-  • This appliance must be properly grounded.
 - Do not ground the appliance to a gas pipe, plastic water pipe, or telephone line.
 - This may result in electric shock, fire, an explosion, or problems with the product.
 - Do not cut or remove the grounding prong from the power cord under any circumstances.
 - Connect the cooktop to a circuit that provides the correct amperage.
-  • Do not install this appliance in a humid, oily or dusty location, or in a location exposed to direct sunlight or water (rain drops).
 - This may result in electric shock or fire.
 - Do not use a damaged power cord or loose wall socket.
 - This may result in electric shock or fire.
 - Do not pull or bend the power cord excessively.
 - Do not twist or tie the power cord.
 - Do not hook the power cord over a metal object, place a heavy object on the power cord, or insert the power cord between objects.
 - This may result in electric shock or fire.
-  If the power cord is damaged, contact your nearest Samsung service center.

SAVE THESE INSTRUCTIONS

CRITICAL USAGE WARNING

⚠ CAUTION

- ★ • If the appliance is flooded by any liquid, please contact your nearest Samsung service center. Failing to do so may result in electric shock or fire.
- If the appliance produces a strange noise, a burning smell, or smoke, unplug the power plug immediately and contact your nearest Samsung service center.
 - Failing to do so may result in electric shock or fire.
- In the event of a gas leak (such as propane gas, LP gas, etc.), ventilate the area immediately. Do not touch the power cord. Do not touch the appliance.
 - A spark may result in an explosion or fire.
- Take care not to contact the cooktop surface with your body while cooking or just after cooking.
 - Failing to do so may result in burns.
- Always observe safety precautions when using your cooktop. Never try to repair the cooktop on your own - there is dangerous voltage inside. If the cooktop needs to be repaired, contact an authorized Samsung service center near you.
- If you use the appliance when it is contaminated by foreign substances such as food waste, it may result in a problem with the appliance.

SAVE THESE INSTRUCTIONS

- ☒ • Do not attempt to repair, disassemble, or modify the appliance yourself.
 - Since a high voltage current enters the product chassis, it may result in electric shock or fire.
 - When a repair is needed, contact your nearest Samsung service center.
- ☑ • If any foreign substance such as water has entered the appliance, contact your nearest Samsung service center.
 - Failing to do so may result in electric shock or fire.
- ☒ • Do not touch the power cord with wet hands.
 - This may result in electric shock.
- Do not turn the appliance off while an operation is in progress.
 - This may cause a spark and result in electric shock or fire.
- Keep all packaging materials well out of the reach of children, as packaging materials can be dangerous to children.
 - If a child places a plastic bag over his or her head, the child can suffocate.
- Do not let children or any person with reduced physical, sensory, or mental capabilities use this appliance unsupervised.
- Keep pets away from the appliance because pets may step on the controls of the appliance, causing a malfunction.
- Make sure that the appliance's controls and cooking areas are out of the reach of children.
 - Failing to do so may result in electric shock, burns, or injury.

SAVE THESE INSTRUCTIONS

Important safety instructions

- ☐ • Do not use or place flammable sprays or objects near the cooktop.
 - Flammable items or sprays can cause fires or an explosion.
- Do not insert fingers, foreign substances, or metal objects such as pins or needles into inlets, outlets, or holes. If foreign substances are inserted into any of these holes, contact your product provider or nearest Samsung service center.
- Never use this appliance for purposes other than cooking.
 - Using the appliance for any purpose other than cooking may result in a fire.
- Never heat plastic or paper containers and do not use them for cooking.
 - Failing to do so may result in a fire.
- Do not heat food wrapped in paper from magazines, newspapers, etc.
 - This may result in a fire.
- Do not hold food in your bare hands during or immediately after cooking.
 - Use cooking gloves. The food may be very hot and you could burn yourself.
 - As the handle and cooktop surfaces may be hot enough to cause burns after cooking, use cooking gloves to protect your hands from burns.

SAVE THESE INSTRUCTIONS

USAGE CAUTIONS

⚠ CAUTION

- ★ • If the surface is cracked, turn the appliance off.
 - Failing to do so may result in electric shock.
- Dishes and containers can become hot. Handle with care.
- Hot foods and steam can cause burns. Carefully remove container coverings, directing the steam away from your hands and face.
- Remove lids from baby food jars before heating. After heating baby food, stir well to distribute the heat evenly. Always test the temperature by tasting before feeding the baby. The glass jar or the surface of the food may appear to be cooler than the interior, which can be hot enough to burn an infant's mouth.
- Take care as beverages or food may be very hot after heating.
 - Especially when feeding a child, make sure that the food or beverage has cooled sufficiently.

SAVE THESE INSTRUCTIONS

- ★ • Take care when heating liquids such as water or other beverages.
 - Make sure to stir during or after cooking.
 - Avoid using a slippery container with a narrow neck.
 - Wait at least 30 seconds after heating before removing the heated liquid.
 - Failing to do so may result in an abrupt overflow of the contents and cause burns.
- ☒ • Do not stand on top of the appliance or place objects (such as laundry, lighted candles, lighted cigarettes, dishes, chemicals, metal objects, etc.) on the appliance.
 - This may result in electric shock, fire, problems with the product, or injury.
- Do not operate the appliance with wet hands.
 - This may result in electric shock.
- Do not spray volatile substances such as insecticide onto the surface of the appliance.
 - As well as being harmful to humans, it may also result in electric shock, fire, or problems with the product.
- Do not put your face or body close to the appliance while cooking.
 - Take care that children do not come too close to the appliance.
 - Failing to do so may result in children burning themselves.

SAVE THESE INSTRUCTIONS

- ☒ • Do not scratch the glass of the cooktop with a sharp object.
 - This may result in the glass being damaged or broken.
- Do not store anything directly on top of the appliance when it is in operation.
- Do not over-heat food.
 - Overheating food may result in a fire.

CRITICAL CLEANING WARNINGS

⚠ CAUTION

- ★ • Do not clean the appliance by spraying water directly on to it.
- Do not use benzene, thinner, or alcohol to clean the appliance.
 - This may result in discoloration, deformation, damage, electric shock, or fire.
- Take care not to hurt yourself when cleaning the appliance (externally or internally).
 - You may hurt yourself on the sharp edges of the appliance.
- Do not clean the appliance with a steam cleaner.
 - This may result in corrosion.
- Keep the cooktop surface clean. Food particles or spattered oils stuck to the cooktop surface can cause paint damage and reduce the efficiency of the cooktop.

SAVE THESE INSTRUCTIONS

Important safety instructions

1. FCC Notice

FCC STATEMENT:

The manufacturer is not responsible for any radio or TV interference caused by unauthorized modification to this microwave oven. It is the responsibility of the user to correct such interference.

This equipment has been tested and found to comply with the limits for a Class B digital device, pursuant to part 15 of the FCC Rules.

These limits are designed to provide reasonable protection against harmful interference in a residential installation. This equipment generates, uses and can radiate radio frequency energy and, if not installed and used in accordance with the instructions, may cause harmful interference to radio communications. However, there is no guarantee that interference will not occur in a particular installation. If this equipment does cause harmful interference to radio or television reception, which can be determined by turning the equipment off and on, the user is encouraged to try to correct the interference by one or more of the following measures:

- Reorient or relocate the receiving antenna.
- Increase the separation between the equipment and receiver.
- Connect the equipment into an outlet on a circuit different from that to which the receiver is connected.
- Consult the dealer or an experienced radio/TV technician for help.

SAVE THESE INSTRUCTIONS

WARNING

Any changes or modifications to this unit not expressly approved by the party responsible for compliance could void the user's authority to operate the equipment.

FCC RF Exposure Requirements

This device complies with FCC RF radiation exposure limits set forth for an uncontrolled environment. The antenna(s) used for this transmitter must not be co-located or operating in conjunction with any other antenna or transmitter and must be installed to provide a separation distance of at least 20cm from all persons.

2. IC Notice

This device contains licence-exempt transmitter(s)/receiver(s) that comply with Innovation, Science and Economic Development Canada's licence-exempt RSS(s). Operation is subject to the following two conditions:

1. This device may not cause interference.
 2. This device must accept any interference, including interference that may cause undesired operation of the device.
- CAN ICES(B)/NMB(B)

SAVE THESE INSTRUCTIONS

IC RADIATION EXPOSURE STATEMENT:

This equipment complies with IC RSS-102 radiation exposure limits set forth for an uncontrolled environment. This equipment should be installed and operated so there is at least 8 inches (20 cm) between the radiator and your body. This device and its antenna(s) must not be co-located or operated in conjunction with any other antenna or transmitter.

CALIFORNIA PROPOSITION 65 WARNING

WARNING

Cancer and Reproductive Harm - www.P65Warnings.ca.gov.

SAVE THESE INSTRUCTIONS

Before you start

About surface cooking

CAUTION

BEFORE COOKING

- Do not use the glass cooktop surface as a cutting board.
- Do not place or store items that can melt or catch fire on the glass cooktop, even when it is not being used.
- Turn the surface units on only after placing cookware on them.
- Do not store heavy items above the cooktop surface. They could fall and damage it.

CAUTION

DURING COOKING

- Do not place aluminum foil or plastic items such as salt and pepper shakers, spoon holders, or plastic wrappings on the cooktop when it is in use.
- Make sure the correct surface unit is turned on.
- Never cook directly on the glass. Always use cookware.
- Always place the pan in the center of the surface unit you are cooking on.
- Never leave surface units unattended while using a high heat setting. Boilovers cause smoking and greasy spillovers that may catch on fire.
- Turn the surface units off before removing cookware.
- Do not use plastic wrap to cover food. Plastic may melt onto the surface and be very difficult to remove.

Before you start

CAUTION

AFTER COOKING

- Do not touch the surface units until they have cooled down.
- The surface may be still be hot and burns may occur if you touch the glass surface before it has cooled down sufficiently.
- Immediately clean spills on the cooking area to prevent a tough cleaning chore later.
- If cabinet storage is located directly above the cooking surface, make sure that the items in it are infrequently used and can be safely stored in an area subjected to heat. Temperatures may be unsafe for items such as volatile liquids, cleaners, or aerosol sprays.

About the radiant surface elements

The temperature rises gradually and evenly. As the temperature rises, the radiant element will glow red. To maintain the selected setting, the element will cycle on and off. The heating element retains enough heat to provide a uniform and consistent heat during the off cycle. For efficient cooking, turn off the element several minutes before cooking is complete. This will allow residual heat to complete the cooking process.

NOTE

Radiant elements have a limiter that allows the element to cycle ON and OFF, even at the HI setting. This helps to prevent damage to the ceramic cooktop. Cycling at the HI setting is normal and can occur if the cookware is too small for the radiant element or if the cookware bottom is not flat.

CAUTION

if the cooktop is installed above an oven, do not use the cooktop while the oven's Self-cleaning function is on.

Location of the surface elements and controls

Cooking zones

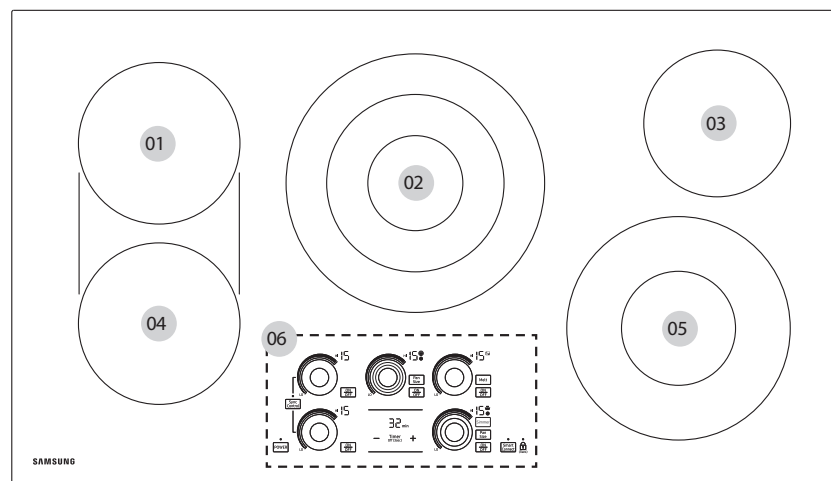

01 Left Rear
(7", 1500 W)

02 Center
(6"/9"/12", 3000W)

03 Right Rear
(6", 1200 W)

04 Left Front
(7", 1500 W)

05 Right Front
(6"/9", 3300W)

06 Control Panel

Control Panel

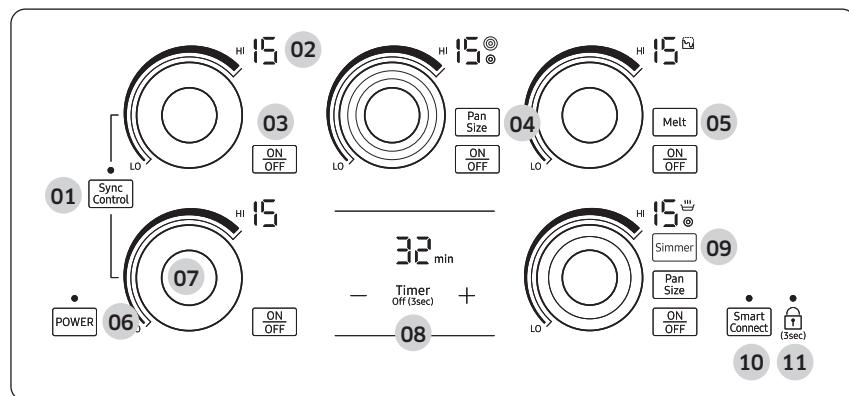

- | | | |
|--|---|---------------------------|
| 01 Sync Control selector | 02 Indicators for heat settings and residual heat | 03 Cooking zone selectors |
| 04 Pan Size selector | 05 Melt selector (🔥) | 06 Power |
| 07 Heat setting selector (Magnetic Knob) | 08 Timer | 09 Simmer selector (👉) |
| 10 Smart Connect | 11 Child lock | |

Magnetic Knob

The magnetic knob is a detachable control knob with a magnetic base you can use to set and adjust the power level of any of the radiant elements on your cooktop easily and intuitively.

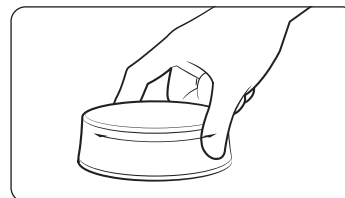

To use the magnetic knob:

1. Place it in the center of the element control of your choice. The knob's magnet holds it in place.
2. Press the **Power** button to turn on the cooktop, and then press the element's **ON/OFF** key within 20 seconds.
3. Grasp and turn the magnetic knob within 10 seconds to set the element's power level.

With the cooktop powered on, if you put the magnetic knob over an unused element on the control panel, the cooktop recognizes the knob and sets the power level to 0. Then, you can change the power level using the knob.

NOTE

You can also set the power level by touching the element control with your finger. See pages 18 and 19.

Before you start

Residual heat indicator

When an individual cooking zone or the cooktop is turned off, the presence of residual heat is shown with an **H** (for “hot”) in the digital display of the appropriate cooking zone. The residual heat indicator goes out only after the cooking zone has cooled.

You can use the residual heat to thaw food or keep food warm.

⚠ WARNING

As long as the residual heat indicator is illuminated, there is a risk of burns.

⚠ WARNING

If the power supply is interrupted, the **H** symbol will go out and information about residual heat will no longer be available. However, you may still be able to burn yourself. This can be avoided by always taking care when near the cooktop.

Cooking areas

- The cooking areas on your cooktop are identified by permanent circles on the glass cooking surface. For the most efficient cooking, fit the pan size to the element size.
- **Pans should not extend more than ½” to 1” beyond the cooking area.**
- When a control is turned on, you can see a glow through the glass cooking surface. **The element will cycle on and off to maintain the preset heat setting, even at high settings.**
- For more information on selecting proper types of cookware, refer to the section “**Using the proper cookware**”.

Initial cleaning

Wipe the ceramic glass surface with a damp cloth and ceramic cooktop glass cleaner.

⚠ WARNING

Do not use caustic or abrasive cleaners. The surface could be damaged.

Operations

Switching the appliance on

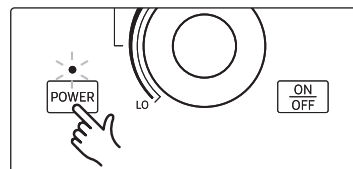

Turn the cooktop on by touching the **POWER** key for approximately 1 second.

NOTE

After you have touched the **POWER** key to switch on your cooktop, you must select an element and power setting within approximately 20 seconds. Otherwise, the cooktop will switch itself off for safety reasons.

Select the cooking zone and heat setting

Single surface unit (left rear, left front, right rear)

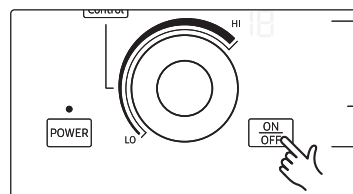

1. To select an element, touch the element's **ON/OFF** key.
 - The digital displays will show **HI**.

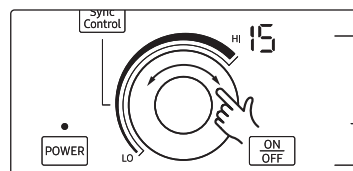

2. To set and adjust the power level, run your finger clockwise or counterclockwise along the surface of the element's control.
 - If you do not set a power level after selecting an element, the element will turn off automatically after 10 seconds.
 - If you have attached the magnetic knob to the element control, grasp and turn the magnetic knob within 10 seconds.

Dual surface unit (right front)

The dual surface unit features inner and outer elements. You can select either element depending on the cookware you are using.

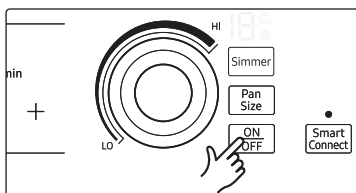

- To select the cooking zone, touch the corresponding cooking zone's selector.
 - The digital displays will show 18.

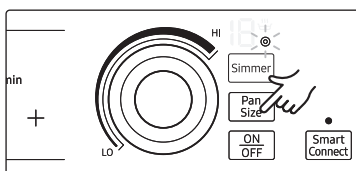

- To select the pan size, touch the **Pan Size** key. When the ☉ indicator turns on, the unit operates in Dual mode.

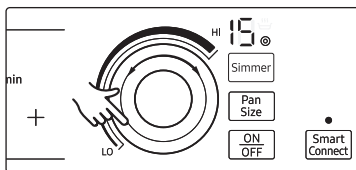

- To set and adjust the power level, run your finger clockwise or counterclockwise along the surface of the element's control.
 - If you do not set a power level after selecting an element, the element will turn off automatically after 10 seconds.
 - If you have attached the magnetic knob to the element control, grasp and turn the magnetic knob within 10 seconds.

Triple surface unit (Center)

The triple surface unit features 3 different heaters so that you can select any heater depending on the size of the container to use.

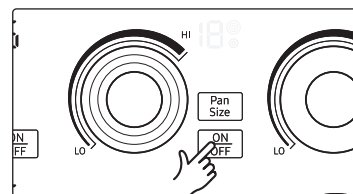

- For selecting the cooking zone, touch the corresponding cooking zone's selector.
 - The digital displays will show 18.

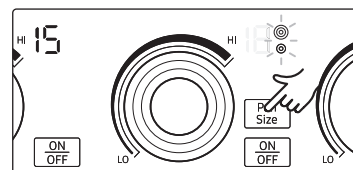

- For selecting the pan size, touch the **Pan Size** key. When the ☉ indicator turns on, the unit operates in Dual mode. When the ☉ indicator turns on, the unit operates in Triple mode.

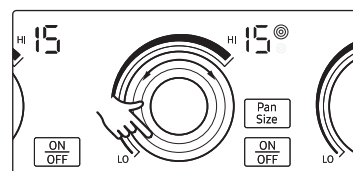

- For setting and adjusting the power level, rotating the magnetic knob.
 - If no key is entered after a burner is selected, the burner will turn off automatically after 10 seconds.

NOTE

You can set a power level from 1 to 15 for the selected cooking zone.

NOTE

If you try to rotate the magnetic knob by grabbing its side or by pushing it, it will not work. Grasp the knob with two fingers, and then turn it.

NOTE

If you turn the magnetic knob while wearing oven gloves, the knob will not work. You must be bare handed.

Operations

Recommended settings

The power levels in the table below are guidelines. The power settings required for various cooking methods depend on a number of variables, including the quality of the cookware being used and the type and amount of food being cooked.

SETTING	POWER LEVELS	TYPE OF COOKING
HIGH	13-15	<ul style="list-style-type: none">Starting most foodsBringing water to a boilQuickly searing meatPan boiling
MEDIUM HIGH	10-12	<ul style="list-style-type: none">Continuing a rapid boilDeep fat frying, pan frying, stir frying
MEDIUM	7-9	<ul style="list-style-type: none">Maintaining a slow boilThickening sauces and graviesSteaming vegetables
MEDIUM LOW	4-6	<ul style="list-style-type: none">Keeping foods cooking, poaching, stewing
LOW	1-3 Melt, Simmer	<ul style="list-style-type: none">Melting chocolate or butterKeeping foods warmSimmering

Griddle (Sync control zone)

Preheat the griddle (MEDIUM HIGH or HIGH) for 5-10 minutes.

Type of cooking	Setting
Pancakes	MEDIUM LOW
French toast	MEDIUM LOW
Fried eggs	MEDIUM
Hamburgers	MEDIUM HIGH - cook to desired brownness
Bacon, sausages	MEDIUM HIGH - cook to desired doneness

NOTE

- The power settings indicated in the table above are provided only as guidelines for your reference.
- You will need to adjust the power settings according to the cookware you are using and the food you are cooking.

Switching the appliance off

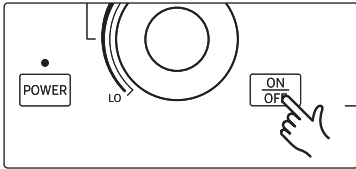

Touch the **ON/OFF** key for the currently operating element, or set the power level to 0 to turn the element off.

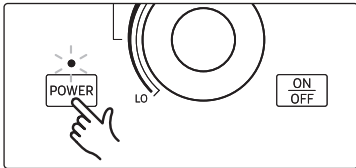

To completely switch off the appliance, touch the **POWER** key for 1 second.

NOTE

After you switch off a single cooking zone or the entire cooking surface, the presence of residual heat will be indicated in the digital displays of the corresponding cooking zones by an **H** (for "hot").

Using the child lock

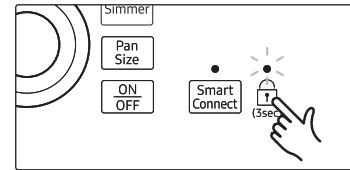

You can use the child lock to safeguard against a child unintentionally turning on a cooking zone and activating the cooking surface. Also, the control panel, with the exception of the **POWER** key, can be locked to prevent the settings from being changed unintentionally, for example, by wiping over the panel with a cloth.

Switching the child safety lock On/Off

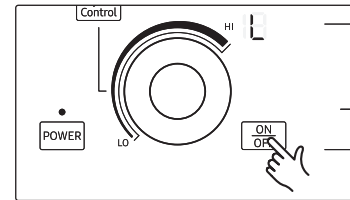

1. Touch the **Child lock**  key for approximately 3 seconds. An acoustic signal will sound as confirmation.



2. Touch any control key.  will appear in the displays, indicating the child lock has been activated.
3. To switch the child lock off, touch the **Child lock**  key again for 3 seconds. An acoustic signal will sound as confirmation.

NOTE

- If you activate the child lock while the cooktop is operating, touch the **POWER** button to turn the cooktop off for safety reasons.
- If the child lock is enabled when the cooktop is not operating, all buttons will be disabled including the **POWER** button.

Operations

Timer

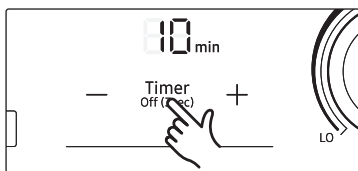

1. Press the **Timer** key. The number 10 will be displayed above the timer display.

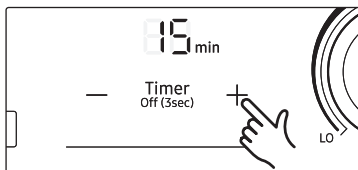

2. Use the **Timer setting selectors** (+ or -) to set the desired amount of time. Then, press **Timer** key again.

NOTE

The timer can be adjusted from 0 to 99.

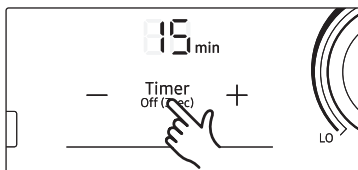

3. To cancel the timer settings, hold down the **Timer** key for 3 seconds.

NOTE

- To change the settings quicker, touch and hold any of the + or - control keys until the desired value is reached.
- When the timer is terminated, it sounds a beep 5 times. However, the cooking zone will not be turned off.

Sync control

You can use Sync Control to operate and control the two elements on the left side simultaneously, as a single cooking zone, and then use the zone for large cookware. (Examples: oval cookware, large spaghetti pots, etc.)

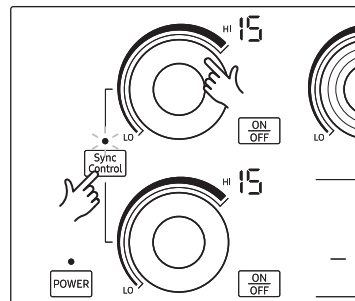

1. Touch the **Sync Control** selector. The two left elements are synced and will now work together.
2. Use an element control as shown to adjust the power level of the two left elements. The power setting displays of the two left side elements (front and rear) will change together.
3. To disable Sync Control, touch the **Sync Control** selector.
 - You can also use the magnetic knob to control the two elements. See page 15.

NOTE

When two currently operating left elements are synced, the power level settings of two elements will be set to the level of the element with the higher setting.

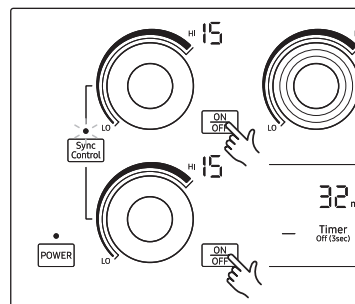

NOTE

To turn the synced elements off, touch the **ON/OFF** key of any synced elements. The two synced elements will turn off simultaneously.

Sound on/off

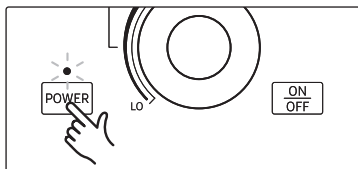

1. Touch the **POWER** key for approximately 1 second.

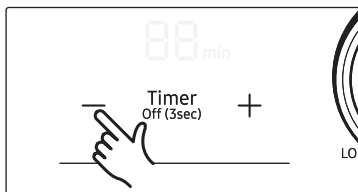

2. Touch the — key for 3 seconds within 10 seconds of pressing the **POWER** key.

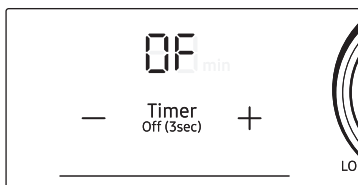

3. Sound will turn off and **0F** will appear in the Timer display.

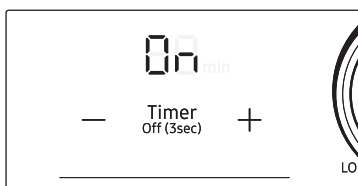

4. To change the Sound setting, repeat Steps 1 and 2. Sound will turn on and **0n** will appear in the Timer display.

NOTE

To change the Sound On/Off setting, you must operate the Sound On/Off function within 10 seconds of turning the power on.

Using the proper cookware

Using the right cookware can prevent many problems, such as uneven cooking or extended cooking times. Using the proper pots and pans will reduce cooking times and cook food more evenly.

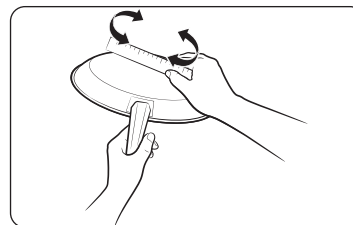

Check for flatness by rotating a ruler across the bottom of the cookware.

CORRECT

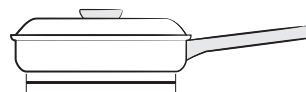

Flat bottom and straight sides.

- Tight fitting lids.
- Weight of handle does not tilt pan.
- Pan is well balanced.
- Pan size matches the amount of food to be prepared and the size of the surface element.
- Made of a material that conducts heat well.

Always match pot diameter to element surface diameter.

INCORRECT

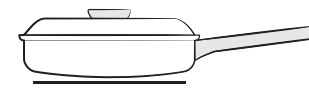

Curved and warped pan bottoms.

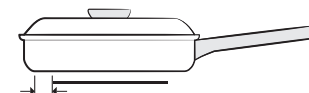

Pan overhangs element by more than one-half inch.

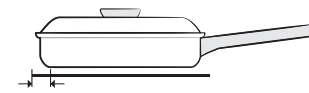

Pan is smaller than element.

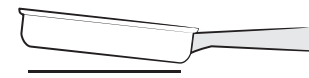

Heavy handle tilts pan.

Operations

Choosing the proper cookware

What your cookware is made of determines how evenly and quickly heat is transferred from the surface element to the pan bottom.

- **ALUMINUM** - Excellent heat conductor. Some types of food will cause the aluminum to darken. (Anodized aluminum cookware resists staining & pitting). If aluminum pans are slid across the ceramic cooktop, they may leave metal marks that resemble scratches. Remove these marks as soon as the cooktop cools down.
- **COPPER** - Excellent heat conductor but discolors easily. May leave metal marks on ceramic glass (To remove, see above.)
- **STAINLESS STEEL** - Slow heat conductor with uneven cooking results. Is durable, easy to clean, and resists staining.
- **CAST IRON** - A poor conductor; retains heat very well. Cooks evenly once cooking temperature is reached. Not recommended for use on ceramic cooktops.
- **ENAMELWARE** - Heating characteristics will vary depending on the base material. Porcelain enamel coating must be smooth to avoid scratching ceramic cooktops.
- **GLASS** - Slow heat conductor. Not recommended for ceramic cooktop surfaces because it may scratch the surface.

Protecting the cooktop

Cleaning

- Clean the cooktop before using it for the first time.
- Clean your cooktop daily or after each use. This will keep your cooktop looking good and can prevent damage.
- If a spillover occurs while you are cooking, immediately clean the spill from the cooking area while it is hot to prevent a tough cleaning chore later. Using extreme care, wipe the spill with a clean, dry towel.
- Do not allow spills to remain on the cooking area or the cooktop trim for a long period of time.
- **Do not** use abrasive cleansing powders or scouring pads which will scratch the cooktop.
- **Do not** use chlorine bleach, ammonia, or other cleansers not specifically recommended for use on a glass-ceramic surface.

Preventing marks and scratches

- **Do not** use glass cookware. It may scratch the cooktop.
- **Do not** place a trivet or wok ring between the cooktop and the pan. These items can mark or scratch the cooktop.
- Make sure the cooktop and the pan bottom are clean.
- **Do not** slide metal pans across the cooktop.

Preventing stains

- **Do not** use a soiled dish cloth or sponge to clean the cooktop surface. A film will remain, which may cause stains on the cooking surface after the area is heated.
- Continuously cooking on a soiled surface can result in a permanent stain.

Preventing other damage

- **Do not** allow plastic, sugar, or foods with high sugar content to melt onto the hot cooktop. Should this happen, clean immediately.
- **Do not** let a pan boil dry as this will damage the cooktop and the pan.
- **Do not** use the cooktop as a work surface or cutting board.
- **Do not** cook food directly on the cooktop. Always use the proper cookware.

Using the smart connect feature

The cooktop has built in a Wi-Fi module that you can use to sync the cooktop with the SmartThings app. On the smartphone app, you can:

- monitor the operating status and the power level settings of the cooktop elements.
- check and change the timer settings.

Functions that can be operated from the SmartThings app may not work smoothly if communication conditions are poor or the product is installed in a place with a weak Wi-Fi signal.

How to connect the cooktop

Before you can use the remote features of your Samsung cooktop, you must pair it to the SmartThings app.

1. Download and open the SmartThings app on your smart device.
2. Follow the app's instructions, and then touch and hold the **Smart Connect** key for 3 seconds.
3. While the connection is being made, the LED indicator above the **Smart Connect** key blinks. Once the process is complete, the indicator glows without blinking. Now the cooktop is connected successfully.
4. If the Smart Connect LED indicator does not turn on, follow the instruction in the app to reconnect.

NOTE

For further instructions, refer to the web manual at www.samsung.com

Wi-Fi On/Off

Touch the **Smart Connect** key to turn on or turn off the Wi-Fi connection.

Using the hood control feature

This product features a Bluetooth device that you can use to connect the cooktop to Samsung hood control models. Through the Bluetooth connection, you can use the hood control function on the SmartThings app.

To find out more about Samsung hood control-enabled models, visit www.samsung.com.

To connect to a hood control model

1. Download and run the SmartThings app on your smartphone. Then, complete the Smart Connect procedure to connect to the cooktop.
2. Follow the Bluetooth instructions of the hood control model and activate the Bluetooth connection.
3. Touch and hold the **Smart Connect** and **Child Lock** buttons simultaneously to make the Bluetooth connection. When the Bluetooth connection is successfully established, **b.t** appears on the display.
4. Follow the instructions in the user manual of the hood control model and the App guide to use the hood control.

NOTE

- If the Smart Connect connection is not successful, you cannot use the SmartThings app to monitor and control the hood.
- Without a Smart Connect connection to the cooktop, you can use a Bluetooth connection to pair the cooktop with the hood and sync them. To do this, follow steps 2 and 3 above.

Maintenance

Care and cleaning of the glass cooktop

Normal daily use cleaning

Use only a ceramic cooktop cleaner. Other creams may not be as effective. By following these steps, you can maintain and protect the surface of your glass cooktop.

1. Before using the cooktop for the first time, clean it with a ceramic cooktop cleaner.
 - This helps protect the top and makes cleanup easier.
 - Daily use of a ceramic cooktop cleaner will help keep the cooktop looking new.
2. Shake the cleaning cream well. Apply a few drops of cleaner directly to the cooktop.
3. Use a paper towel or a cleaning pad for ceramic cooktops to clean the entire cooktop surface.
4. Use a dry cloth or paper towel to remove all cleaning residue. No need to rinse.

⚠ WARNING

DAMAGE to your glass surface may occur if you use scrub pads other than those recommended.

Removing burned-on residue

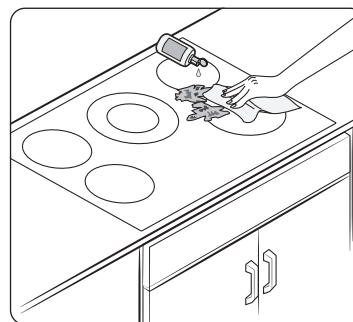

1. Allow the cooktop to cool.
2. Spread a few drops of ceramic cooktop cleaner on the entire burned residue area.
3. Using a cleaning pad for ceramic cooktops, rub the residue area, applying pressure as needed.
4. If any residue remains, repeat the steps listed above as needed.
5. For additional protection, after all residue has been removed, polish the entire surface by applying ceramic cooktop cleaner with a paper towel.

Removing heavy, burned-on residue

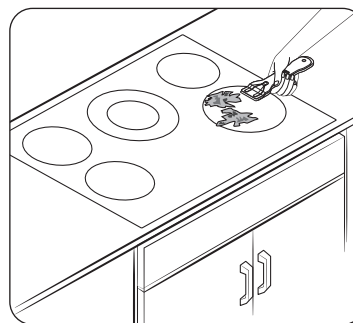

1. Allow the cooktop to cool.
2. Use a single-edge razor-blade scraper at approximately a 45° angle against the glass surface and scrape the soil. It will be necessary to apply pressure to remove the residue.
3. After scraping with the razor scraper, spread a few drops of ceramic cooktop cleaner on the entire burned residue area. Use a cleaning pad to remove any remaining residue. (Do not scrape the seal around the edges of the cooktop.)
4. For additional protection, after all residue has been removed, polish the entire surface by applying ceramic cooktop cleaner with a paper towel.

Removing metal marks and scratches

1. Be careful not to slide pots and pans across your cooktop. It will leave marks on the cooktop surface. You can remove these marks by applying ceramic cooktop cleaner with a cleaning pad for ceramic cooktops.
2. If pots with a thin overlay of aluminum or copper are allowed to boil dry, the overlay may leave black discoloration on the cooktop. You should remove this discoloration immediately or it may become permanent.

⚠️ WARNING

Carefully check the bottoms of pans for roughness that may scratch the cooktop.

Cleaning the cooktop seal

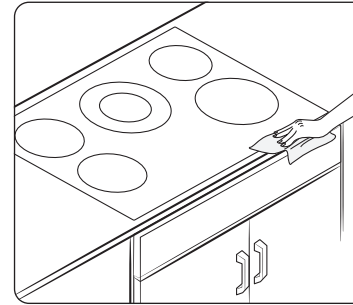

To clean the seal around the edges of the glass, lay a wet cloth on it for a few minutes, then wipe clean with a nonabrasive cleaner.

Potential for permanent damage to the glass surface

- Sugary spillovers (such as jellies, fudge, candy, syrups) or melted plastics can cause pitting of the surface of your cooktop. This is not covered under the warranty. You should clean the spill while it is still hot. Take special care when removing hot substances. Refer to the section below.
- When using a scraper, be sure it is new and the razor blade is still sharp. Do not use a dull or nicked blade.

Cleaning sugary spills and melted plastic

1. Turn off all surface units. Remove hot pans.
2. Wearing an oven mitt, use a single-edge razor-blade scraper to move the spill to a cool area of the cooktop. Remove the spill with paper towels.
3. Any remaining spillover should be left until the surface of the cooktop has cooled.
4. Don't use the surface units again until all of the residue has been completely removed.

📖 NOTE

If pitting or indentations in the glass surface have already occurred, the cooktop glass will have to be replaced. In this case, service will be necessary.

Troubleshooting

Troubleshooting

Samsung works hard to ensure that you don't have problems with your new cooktop. If you run into unexpected trouble, look first for a solution in the tables below. If you're still having trouble after trying the suggested solution, call Samsung at 1-800-SAMSUNG (1-800-726-7864).

Problem	Possible cause	Solution
The surface units will not maintain a rolling boil or will not cook fast enough.	You may be using inappropriate cookware.	Use pans which are flat and match the diameter of the surface unit selected.
	In some areas, the power (voltage) may be low.	Cover the pan with a lid until the desired heat is obtained.
The surface units will not turn on.	A fuse in your home may be blown or a circuit breaker may have tripped.	Replace the fuse or reset the circuit breaker.
	The cooktop controls are set improperly.	Check if the correct control is set for the surface unit you are using.
Areas of discoloration on the cooktop.	Food spillover was not cleaned.	Refer to the section on the care and cleaning of the glass cooktop on page 24.
	The surface is hot and the model features a light-colored cooktop.	This is normal. The surface may appear discolored when it is hot. This is temporary and will disappear as the glass cools.

Problem	Possible cause	Solution
The surface unit frequently cycles on and off.	The element will cycle on and off to maintain the power setting.	This is normal operation, and not a system failure. Cycling at the high power setting is normal and can occur if the cookware is too small for the cooktop element or if the cookware bottom is not flat. Use the cooktop as usual.
The surface unit stops glowing when changed to a lower setting.	This is normal. The unit is still on and hot.	
Scratches or abrasions on the cooktop surface.	The cooktop is being cleaned improperly.	Scratches are not removable. Tiny scratches will become less visible in time as a result of cleaning. Use ceramic glass top cleaning cream. Do not use chemical or corrosive agents. These agents may damage the surface of the product.
	Cookware with rough bottoms was used on the cooktop or there were coarse particles (eg. salt or sand) present between the cookware and the surface of the cooktop.	To avoid scratches, follow the recommended cleaning procedures. Make sure cookware bottoms are clean before use, and use cookware with smooth bottoms.
Cookware has been slid across the cooktop surface.		

Problem	Possible cause	Solution
Brown streaks or specks.	Boilovers have been cooked onto the surface.	<ul style="list-style-type: none"> Wait until the surface cools down. Then, use a single-edge razor-blade scraper at approximately a 45° angle against the glass surface to remove the soil. See the section on the care and cleaning of the glass cooktop on page 24.
Areas of discoloration with metallic sheen.	Mineral deposits from water and food have been left on the surface of the cooktop.	<ul style="list-style-type: none"> Remove using a ceramic-glass cooktop cleaning cream. Use cookware with clean, dry bottoms. Clean the cooktop with a ceramic cleaning agent regularly every week.
Cracking or "popping" sound.	This is the sound of the metal heating and cooling during cooking.	This is normal operation and not a system failure. Use the cooktop as usual.

Information codes

Information code	Possible cause	Solution
C3, C4	Sensor malfunctions	Turn off the cooktop and then restart. If the problem continues, unplug the power cord for 30 seconds or more and then reconnect. If the problem is not fixed, please contact a local Samsung service center.
d0	A key is pressed for more than 8 seconds.	Check if the key pad is wet or a key is depressed. If the problem continues, restart the appliance using the POWER button. If the problem still continues, contact a local Samsung service center.
F0	Communications between main and sub PCBs failed.	Restart the appliance using the POWER button. If the problem continues, disconnect power for more than 30 seconds. Then, restart the appliance. If the problem still continues, contact a local Samsung service center.
F1	Communications between main and EEPROM failed.	
F2	The touch-enabled IC communicates abnormally.	

Warranty (U.S.A)

PLEASE DO NOT DISCARD. THE PAGE REPLACES THE WARRANTY PAGE IN THE USE & CARE GUIDE

Samsung ELECTRIC COOKTOP

LIMITED WARRANTY TO ORIGINAL PURCHASER WITH PROOF OF PURCHASE

This Samsung brand product, as supplied and distributed by Samsung ELECTRONICS AMERICA INC. (Samsung) and delivered new, in the original carton to the original consumer purchaser, is warranted by Samsung against manufacturing defects in materials or workmanship for the limited warranty period, starting on the date of delivery to the original consumer purchaser, of:

One (1) Year Parts and Labor

This limited warranty is valid only on products purchased and used in the United States that have been installed, operated, and maintained according to the instructions attached to or furnished with the product. To receive warranty service, the purchaser must contact Samsung at the address or phone number provided below for problem determination and service procedures. Warranty service can only be performed by a Samsung authorized service center. The original dated bill of sale and/or proof of delivery must be presented upon request as proof of purchase to Samsung or Samsung's authorized service center to receive warranty service.

Samsung will provide in-home service within the contiguous United States during the warranty period at no charge, subject to availability of Samsung authorized servicers within the customer's geographic area. If in-home service is not available, Samsung may elect, at its option, to provide transportation of the product to and from an authorized service center. If the product is located in an area where service by a Samsung authorized servicer is not available, you may be responsible for a trip charge or required to bring the product to a Samsung authorized service center for service.

To receive in-home service, product must be unobstructed and accessible to the service agent.

During the applicable warranty period, a product will be repaired, replaced, or the purchase price refunded, at the sole option of Samsung. Samsung may use new or reconditioned parts in repairing a product, or replace the product with a new or reconditioned product. Replacement parts and products are warranted for the remaining portion of the original product's warranty or ninety (90) days, whichever is longer. All replaced parts and products are the property of Samsung and you must return them to Samsung.

This limited warranty covers manufacturing defects in materials or workmanship encountered in normal household, noncommercial use of this product and shall not cover the following: damage that occurs in shipment, delivery, installation, and uses for which this product was not intended; damage caused by unauthorized modification or alteration of the product; product where the original factory serial numbers have been removed, defaced, changed in any way, or cannot be readily determined; cosmetic damage including scratches, dents, chips, and other damage to the product's finishes; damage caused by abuse, misuse, pest infestations, accident, fire, floods, or other acts of nature or God; damage caused by use of equipment, utilities, services, parts, supplies, accessories, applications, installations, repairs, external wiring or connectors not supplied or authorized by Samsung; damage caused by incorrect electrical line current, voltage, fluctuations and surges; damage caused by failure to operate and maintain the product according to instructions; in-home instruction on how to use your product; and service to correct installation not in accordance with electrical or plumbing codes or correction of household electrical or plumbing (i.e., house wiring, fuses, or water inlet hoses). In addition, damage to the glass cooktop caused by (i) use of cleaners other than the recommended cleaners and pads or (ii) hardened spills of sugary materials or melted plastic that are not cleaned according to the directions in the use and care guide are not covered by this limited warranty.

The cost of repair or replacement under these excluded circumstances shall be the customer's responsibility.

Visits by an authorized servicer to explain product functions, maintenance or installation are not covered by this limited warranty. Please contact Samsung at the number below for assistance with any of these issues.

Warranty (CANADA)

EXCLUSION OF IMPLIED WARRANTIES

IMPLIED WARRANTIES, INCLUDING THE IMPLIED WARRANTIES OF MERCHANTABILITY OR FITNESS FOR A PARTICULAR PURPOSE, ARE LIMITED TO ONE YEAR OR THE SHORTEST PERIOD ALLOWED BY LAW. Some states do not allow limitations on how long an implied warranty lasts, so the above limitations or exclusions may not apply to you. This warranty gives you specific rights, and you may also have other rights, which vary from state to state.

LIMITATION OF REMEDIES

YOUR SOLE AND EXCLUSIVE REMEDY IS PRODUCT REPAIR, PRODUCT REPLACEMENT, OR REFUND OF THE PURCHASE PRICE AT Samsung's OPTION, AS PROVIDED IN THIS LIMITED WARRANTY. Samsung SHALL NOT BE LIABLE FOR SPECIAL, INCIDENTAL OR CONSEQUENTIAL DAMAGES, INCLUDING BUT NOT LIMITED TO TIME WAY FROM WORK, HOTELS AND/OR RESTAURANT MEALS, REMODELING EXPENSES, LOSS OF REVENUE OR PROFITS, FAILURE TO REALIZE SAVINGS OR OTHER BENEFITS REGARDLESS OF THE LEGAL THEORY ON WHICH THE CLAIM IS BASED, AND EVEN IF Samsung HAS BEEN ADVISED OF THE POSSIBILITY OF SUCH DAMAGES. Some states do not allow exclusion or limitation of incidental or consequential damages, so the above limitations or exclusions may not apply to you. This warranty gives you specific rights, and you may also have other rights, which vary from state to state.

Samsung does not warrant uninterrupted or error-free operation of the product. No warranty or guarantee given by any other person, firm, or corporation with respect to this product shall be binding on Samsung.

To obtain warranty service, please contact Samsung at:

Samsung Electronics America, Inc.
85 Challenger Road
Ridgefield Park, NJ 07660
1-800-SAMSUNG (726-7864) and www.samsung.com/us/support

Registration

Please register your product online at www.samsung.com/register.

Questions

For questions about features, operation/performance, parts, accessories, or service, call 1-800-SAMSUNG (726-7864), or visit our Web site at www.samsung.com/us/support.

Model # _____ Serial # _____

Please attach your receipt (or a copy) to this manual. You may need it, along with your model and serial number, when calling for assistance.

PLEASE DO NOT DISCARD. THIS PAGE REPLACES THE WARRANTY PAGE IN THE USE & CARE GUIDE

Samsung ELECTRIC COOKTOP

LIMITED WARRANTY TO ORIGINAL PURCHASER

This Samsung brand product, as supplied and distributed by Samsung ELECTRONICS CANADA, INC. (Samsung) and delivered new, in the original carton to the original consumer purchaser, is warranted by Samsung against manufacturing defects in materials and workmanship for a limited warranty period of:

**One (1) Year Parts and Labor, Five (5) Years Parts Warranty
For Glass Cooktop and Radiant Heater**

During this limited additional four-years warranty, you will responsible for any labor or in-home service.

This limited warranty begins on the original date of purchase, and is valid only on products purchased and used in the CANADA. To receive warranty service, the purchaser must contact Samsung for problem determination and service procedures. Warranty service can only be performed by a Samsung authorized service center. The original dated bill of sale must be presented upon request as proof of purchase to Samsung or Samsung's authorized service center. Samsung will provide in-home service during the warranty period at no charge subject to availability within the contiguous CANADA. In home service is not available in all areas. To receive in home service, the product must be unobstructed and accessible to the service agent. If service is not available Samsung may elect to provide transportation of the product to and from an authorized service center.

Warranty (CANADA)

Samsung will repair or replace this product, at our option and at no charge as stipulated herein, with new or reconditioned parts or products if found to be defective during the limited warranty period specified above. All replaced parts and products become the property of Samsung and must be returned to Samsung. Replacement parts and products assume the remaining original warranty, or ninety (90) days, whichever is longer. This limited warranty covers manufacturing defects in materials and workmanship encountered in normal, noncommercial use of this product and shall not apply to the following: damage which occurs in shipment; delivery and installation; applications and uses for which this product was not intended; altered product or serial numbers; cosmetic damage or exterior finish; accidents, abuse, neglect, fire, water, lightning or other acts of nature; use of products, equipment, systems, utilities, services, parts, supplies, accessories, applications, installations, repairs, external wiring or connectors not supplied or authorized by Samsung which damage this product or result in service problems; incorrect electrical line voltage, fluctuations and surges; customer adjustments and failure to follow operating instructions, maintenance and environmental instructions that are covered and prescribed in the instruction book; product removal and reinstallation; problems caused by pest infestations, and overheating or overcooking by user. This limited warranty shall not cover cases of incorrect electric current, voltage or supply, light bulbs, house fuses, house wiring, cost of a service call for instructions, or fixing installation errors. Furthermore, damage to the glass cooktop caused by the use of cleaners other than the recommended cleaners and pads, damage to the glass cook top caused by hardened spills of sugary materials or melted plastic that are not cleaned according to the directions in the use and care guide are not covered. Samsung does not warrant uninterrupted or error-free operation of the product.

EXCEPT AS SET FORTH HEREIN THERE ARE NO WARRANTIES ON THIS PRODUCT EITHER EXPRESS OR IMPLIED AND Samsung DISCLAIMS ALL WARRANTIES INCLUDING, BUT NOT LIMITED TO, ANY IMPLIED WARRANTIES OF MERCHANTABILITY, INFRINGEMENT OR FITNESS FOR A PARTICULAR PURPOSE. NO WARRANTY OR GUARANTY GIVEN BY ANY PERSON, FIRM OR CORPORATION WITH RESPECT TO THIS PRODUCT SHALL BE BINDING ON Samsung. Samsung SHALL NOT BE LIABLE FOR LOSS OF REVENUE OR PROFITS, FAILURE TO REALIZE SAVINGS OR OTHER BENEFITS, OR ANY OTHER SPECIAL, INCIDENTAL OR CONSEQUENTIAL DAMAGES CAUSED BY THE USE, MISUSE OR INABILITY TO USE THIS PRODUCT, REGARDLESS OF THE LEGAL THEORY ON WHICH THE CLAIM IS BASED, AND EVEN IF Samsung HAS BEEN ADVISED OF THE POSSIBILITY OF SUCH DAMAGES. NOR SHALL RECOVERY OF ANY KIND AGAINST Samsung BE GREATER IN AMOUNT THAN THE PURCHASE PRICE OF THE PRODUCT SOLD BY Samsung AND CAUSING THE ALLEGED DAMAGE. WITHOUT LIMITING THE FOREGOING, PURCHASER ASSUMES ALL RISK AND LIABILITY FOR LOSS, DAMAGE OR INJURY TO PURCHASER AND PURCHASER'S PROPERTY AND TO OTHERS AND THEIR PROPERTY ARISING OUT OF THE USE, MISUSE OR INABILITY TO USE THIS PRODUCT. THIS LIMITED WARRANTY SHALL NOT EXTEND TO ANYONE OTHER THAN THE ORIGINAL PURCHASER OF THIS PRODUCT, IS NONTRANSFERABLE AND STATES YOUR EXCLUSIVE REMEDY.

Some states do not allow limitations on how long an implied warranty lasts, or the exclusion or limitation of incidental or consequential damages, so the above limitations or exclusions may not apply to you. This warranty gives you specific legal rights, and you may also have other rights which vary from state to state.

To obtain warranty service, please contact Samsung at:

Samsung Electronics Canada Inc.
2050 Derry Road West, Mississauga, Ontario L5N 0B9 Canada
1-800-SAMSUNG (726-7864) and www.samsung.com/ca/support (English)
www.samsung.com/ca_fr/support (French)

Appendix

Open Source Announcement

The software included in this product contains open source software. You may obtain the complete corresponding source code for a period of three years after the last shipment of this product by sending an email to <mailto:oss.request@samsung.com>.

It is also possible to obtain the complete corresponding source code in a physical medium such as a CD-ROM; a minimal charge will be required.

The following URL <http://opensource.samsung.com/opensource/SimpleConnectTP/seq/0> leads to the download page of the source code made available and open source license information as related to this product. This offer is valid to anyone in receipt of this information.



Model name & serial number

Both the model name and the serial number are labeled on the side of the cooktop base.

For later use, write down the information onto the current page.

Model Name _____

Serial Number _____



Scan the QR code* or visit
www.samsung.com/spsn
to view our helpful
How-to Videos and Live Shows
*Requires reader to be installed on your smartphone

Scan this with your smartphone

Please be advised that the Samsung warranty does NOT cover service calls to explain product operation, correct improper installation, or perform normal cleaning or maintenance.

QUESTIONS OR COMMENTS?

COUNTRY	CALL	OR VISIT US ONLINE AT
U.S.A Consumer Electronics	1-800-SAMSUNG (726-7864)	www.samsung.com/us/support
CANADA	1-800-SAMSUNG (726-7864)	www.samsung.com/ca/support (English) www.samsung.com/ca_fr/support (French)

